

Intalox
PACKED TOWER SYSTEMS™

Plastic Packed Tower Internals

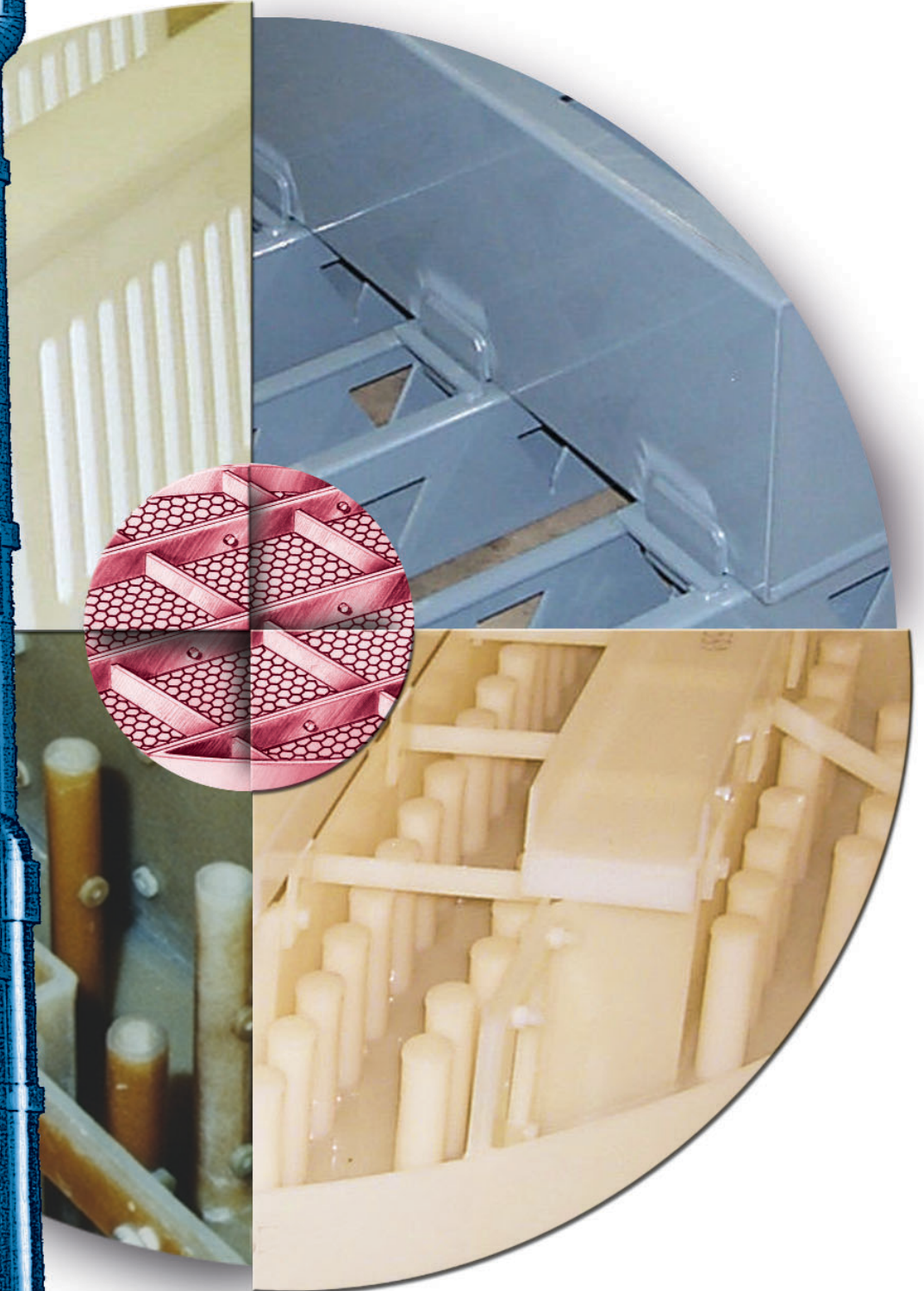
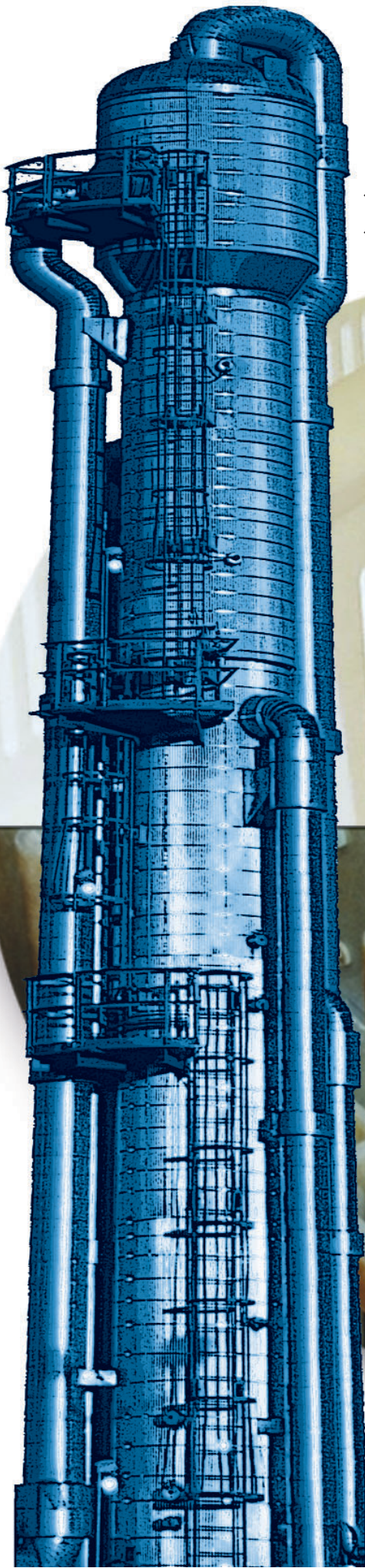

KOCH-GLITSCH®

Plastic Tower Internals Guide

Koch-Glitsch's dedication to state-of-the-art mass transfer equipment has produced a complete line of plastic packed tower internals. This has been achieved by 20 years of testing and supplying **INTALOX**® Distribution Systems. By understanding the important role that liquid and vapor distribution plays, Koch-Glitsch can design packed columns to deliver predictable performance.

INTALOX Packed Tower Systems combine INTALOX liquid and vapor distribution with **FLEXIPAC**® Structured Packing, **INTALOX SNOWFLAKE**® and **BETA RING**™ High Performance Random Packing, and **CASCADE MINI-RINGS**® High Capacity Random Packing.

Koch-Glitsch also offers traditional internals for packed towers used in less demanding services. Refer to pages 3 and 4 for a discussion of the importance of liquid and vapor distribution and the requirements to consider when selecting INTALOX or traditional distributors.

All internals described in this brochure can be manufactured from all formable and weldable sheet thermoplastics, including PTFE, and many thermosetting fiber-reinforced materials.

Similar versions of many of the distributors described in this catalog are also available in a variety of metal materials. Contact your Koch-Glitsch representative to determine if there is a comparable metal packing and to request the metal packing brochure (KGMTIG).

For column packings, the following brochures are available:

- Plastic Packing - KGPP
- **IMTP**® Random Packing - KGIMTP
- Metal Random Packing - KGMRP

Table of Contents

Device Type and Model	Description	Old NorPro Model	Old Koch Model	Old Glitsch Model	Page
INTALOX® Liquid Distributors					
	TP & TS206 Orifice Pan	106			5
	TP & TS236 Channel Elevated Orifice				5
	TP & TS276 Bottom Orifice Trough	136			6
INTALOX® Redistributors					
	TP & TS207 Orifice Pan	107			5
	TP & TS237 Channel Elevated Orifice	137			5
Traditional Liquid Distributors					
	TP & TS905 V-notch Riser Pan	798			7
	TP & TS906 Bottom Orifice Pan	845		DRO-601	7
	TP & TS985 Weir Trough	806	310	VDN-701,711	8
	TP & TS916 Bottom Orifice Deck	816,916	301A,B,C	RTD-551,553	8
	TP & TS976 Bottom Orifice Trough				9
Traditional Liquid Redistributors					
	TP & TS917 Bottom Orifice Deck	817, 917	301 A,B,D	RTD-552,554	8
Enclosed Liquid Distributors					
	TP & TS941 Ladder Arm	844	342	POH-901	10
	TP & TS943 Spray Nozzle	1044	344	SNH-951-X	10
Liquid Feed Devices					
	TP & TS219 Feed Pipe	119,129			11
	TP & TS719 Feed Pipe	719,729			11
	TP & TS239 Bayonet Feed Pipe				12
Packing Bed Limiters					
	TP & TS803 Structured Packing	133	403	H DG-421	13
	TP805 Random Packing	103	104		14
	TP & TS825 Random Packing, Wall Attached	823		BLM-421	14
Packing Support Plates					
	TP & TS814 Random Packing/Gas Injection	818	101	UTS-218	15
	TP & TS804 Random Packing/Gas Injection	804	101R	UTS-201	16
	TP & TS802 Structured Packing	134	102	HPS-121	16
	TS834 & TS844 Random Packing/Gas Injection	819,1019	103	UTS-209	17
	TP & TS854 Heavy-duty Random Packing/Gas Injection				18

- Prefix TP refers to thermoplastic materials.

- Prefix TS refers to thermoset materials, commonly called FRP or GRP.

Materials of Construction and Mechanical Details

Plastic tower internals are available in thermoplastic [TP] and fiber-reinforced thermoset [TS] materials. Product model numbers are prefixed with the material type. For example, Model TP206 is the model number for a thermoplastic Model 206 orifice-pan liquid distributor.

Common TP materials:

- Polypropylene [PP]
- Polyethylene [PE]
- Polyvinylchloride [PVC]
- Chlorinated Polyvinylchloride [CPVC]
- Polyvinylidene Fluoride [PVDF]
- Polytetrafluoroethylene [PTFE]
- Ethylene-chlorotrifluoroethylene [ECTFE]

Other materials are available upon request.

Not all models are available in PTFE because of manufacturing process limitations for this material.

Temperature Limits for TP materials

The table below shows approximate temperature limits for thermoplastic internals. Span in the column, process operating temperature, and loads determine the life of an internal. All plastics deform under stress over time. In many cases, heavy-duty designs are used to obtain reasonable service life of the internals.

Material	Approximate Operating Temperature °F [°C]
PP	180 [82]
PE	155 [68]
PVC	150 [66]
CPVC	155 [68]
PVDF	230 [110]
PTFE	392 [200]

Common TS materials:

- Polyester (such as Atlac® 382-05A, Hetron® 700, Dion® 6694)
- Vinyl Ester (such as Derakane® 411-350, Atlac® 580-05A, Hetron® 922, Dion® 9100, Corezyn)

Other materials are available upon request.

The fabrication process for TS materials includes:

- A reinforcing mat for all resins listed above is of corrosion resistant "E" type glass fibers.
- The standard curing system is MEKP/Cobalt Napthenate for polyesters, vinyl esters, and high temperature vinyl esters. Other common curing systems include BPO/DMA or CHP/Cobalt Napthenate.
- Exposed surfaces can be covered with one ply of Nexus (R) veil (this is the standard for Koch-Glitsch in the United States). Two plies are optional. "C" glass veil is available for certain services.
- Cut edges and weld joints are sealed with a gel coat of cured resin as standard.

Gasketing

For multi-piece distributors, redistributors and feed devices requiring gasketed joints, many choices of gasket material are available. The gasketing must be of a soft material to be effective. Expanded PTFE gasketing is standard, but other materials can be supplied. Flange gaskets are supplied as standard only when both mating flanges are part of the supply. When a flange gasket is to be supplied for mating to vessel flanges, the gasket must be specified.

Bolting

Except for specific sizes for pipe flanges, all thermoplastic fasteners will be 1/2 in. [M12] unless otherwise specified. On TS models, the standard bolting is Polypropylene. Other thermoplastic or metal materials can be supplied.

Ledge Clamps

Ledge clamps can be supplied in thermoplastic, thermoset, or metal materials. The best choice for a given service may not be the same material as the rest of the internals.

Scope of Supply

For the internals in this brochure, Koch-Glitsch supplies all removable parts except for support beams and some gasketing (refer to the Gasketing section on this page). The internals do not include vessel attachments for connection or support, although these may be quoted and supplied separately. Examples of vessel attachments that may be required are:

- Support ledges
- Sump frames
- Internal flanges at feed inlet nozzles
- Wall clips for support

Minimum Ledge Widths

All dimensions are expressed as inches [millimeters]

Tower ID	Internals Resting on or Clamped to Ledge	Internals Through-Bolted or Using Leveling Screws
Up to 18 [Up to 457]	0.75 [20]	1.5 [40]
18.1 – 24.24 [458 – 615]	1.0 [25]	1.5 [40]
24.25 – 48.24 [616 – 1225]	1.5 [40]	2.0 [50]
48.25 – 72.24 [1226 – 1835]	2.0 [50]	2.0 [50]
72.25 – 96.5 [1836 – 2450]	2.5 [65]	2.5 [65]
96.6 – 144.5 [2451 – 3670]	3.0 [75]	3.0 [75]
144.6 – 168.7 [3671 – 4285]	3.5 [90]	3.5 [90]
168.8 – 216.3 [4286 – 5495]	4.0 [100]	4.0 [100]
216.4 – 240.5 [5496 – 6110]	4.5 [115]	4.5 [115]

If the ledge size is other than listed above, special consideration must be given to the plate diameter and vessel tolerances.

Liquid Distributors

Liquid Distribution

Liquid distributors are used above each bed of packing in a packed column to provide uniform liquid distribution. The distributor, depending on its design features, is generally located 6 to 8 in. [150 to 200 mm] above the packing. The distributor type determines vertical spacing and the proper distance needed to disengage the vapor phase from the packing before the vapor passes through the distributor gas passage area.

An ideal distributor has the following attributes, each providing a specific effect on the overall performance of the packed tower:

- Uniform liquid distribution
- Resistance to plugging or fouling
- Wide operating range
- Low vapor phase pressure drop
- Minimal use of vessel height
- Strength for long life without sagging

These important attributes are well understood by Koch-Glitsch and have been incorporated in Koch-Glitsch distributors since the 1980s. They are an integral part of design of the plastic INTALOX® distributors.

Koch-Glitsch offers two categories of liquid distributors to meet the requirements of various services:

- INTALOX Distributors
- Traditional Distributors

In choosing which category to use, it is important to know whether the liquid distribution quality will significantly affect the overall tower performance.

INTALOX Distributors

INTALOX distributors are designed to high standards of distribution uniformity, with emphasis on a uniform pattern of distribution points and minimal variation of flow among points. They provide distribution quality close to that achieved in metal high-performance INTALOX distributors.

Koch-Glitsch plastic INTALOX distributors are used for absorption services with multiple transfer units, solvent desorption "back pressure," close approach to phase equilibrium, or minimal solvent consumption. These columns can be sensitive to liquid distribution quality. In stripping and heat transfer services, similar issues of phase equilibrium and close temperature approach indicate INTALOX distributors should be used.

Because challenging services often use the best packing, INTALOX distributors are used with FLEXIPAC structured packing, INTALOX SNOWFLAKE and BETA RING high performance random packing, and CASCADE MINI-RINGS high capacity random packing.

Traditional packings may be used with INTALOX distributors, such as when a process is licensed and specified with a certain type of packing.

Traditional Distributors

Traditional distributors generally have less uniform distribution patterns and more flow variation between distribution points. In columns that are not sensitive to liquid distribution quality, they may be used for their versatility, fouling resistance, or low cost.

Koch-Glitsch plastic traditional distributors are used for absorption services with few transfer units, no solvent desorption "back pressure," no significant approach to equilibrium, or excess solvent circulation. These columns are generally insensitive to liquid distribution quality. In stripping and heat transfer services, similar issues of no "back pressure," excess quench liquid, or wide temperature approaches indicate that traditional distributors will work well.

Because simpler services often use long-established packings, traditional distributors are often used with **FLEXIRING®** Packing and Super INTALOX Saddles.

High performance packing may be used with traditional distributors when only certain aspects of high-performance packing are desired. Examples include use of INTALOX SNOWFLAKE packing for its high capacity or use of FLEXIPAC structured packing for its low pressure drop. In addition, severely fouling services may require large weirs, which are available only with traditional distributors.

Liquid Redistribution

There are six reasons to separate a single packed bed into two packed beds and redistribute the liquid:

- Feed introduction
- Product side draw
- High transfer unit count
- Desire to cross-mix the liquid
- Liquid maldistribution
- Physical weight of the packed bed

A conservative rule-of-thumb is to limit a single packed bed of plastic packing to no more than 10 transfer units. In addition, the depth of a single bed should be no more than 15 times the column diameter. Both of these limits can be exceeded in some cases.

Liquid redistribution in columns with multiple packed beds can be accomplished by either of the following methods:

- Using a liquid collector plate below the upper bed to feed a liquid distributor that is located above the lower bed.
- Using a liquid redistributor between the beds to combine the liquid collection and distribution into one device, as illustrated on page 19.

Liquid Distribution Issues

Distribution Point Density

The density of the distribution points can affect the efficiency of the top of a packed bed. For example, high point densities can make the distributor more prone to fouling because of smaller orifices. However, with the commonly used random and structured packings, the effect of point density is relatively minor. The difference between 5.5 and 14.5 points/ft² [60 to 155 pts/m²] has a slight effect on the packing Height of a Transfer Unit (HTU).

Point density is not the key to liquid distribution quality.

Cross Flow Capacity

At high liquid rate, the cross flow capability of a distributor and its pre-distribution system are important. Gravity-fed distributors are dependent on liquid level to determine flow; therefore, it is important to balance the liquid properly to provide uniform point-to-point flow. Pre-distribution is achieved by feed pipes and parting boxes. The pre-distribution system must properly meter liquid to one or more appropriate points on the distributor without inducing excessive horizontal velocity, gradients in liquid head, or turbulence. The design of the pre-distribution system becomes increasingly complex as the specific liquid rate and the column diameter increases.

Fouling

For a distributor to perform correctly, the metering device must not become fouled. There are several sources of fouling materials: polymerization, non-soluble deposits, scale, construction debris, sediment, and so forth. Precautions should be taken to keep fouling materials out of the column, because external strainers and filters are much easier to clean than distributors. If it is not possible to eliminate all external fouling sources, or if the source of the fouling material is within the column itself, then the distributor should be considered for its fouling resistance.

The order of fouling resistance of various metering devices on liquid distributors, starting with the most resistant is:

- V-notch weir
- Spray distributor
- Slotted weir
- Elevated orifice
- Bottom orifice

Orifice Size

In gravity-fed distributors, the orifice size depends on the distribution point density, the specific liquid rate and height of the liquid. For a single-level orifice with an operating range of 60 to 120% of the design flow, the approximate orifice size is shown in the chart below.

Operating Range

A distributor performs best at its design liquid flow rate. As the rate decreases and the liquid head drops, levelness of the distributor and hydraulic gradients on the distributor become a larger percentage of the operating liquid head. At some turndown rate, the point-to-point flow variation will fall outside of acceptable limits. Plastic INTALOX distributors are designed for a maximum flow variation, defined as the coefficient of variation (Cv) of no more than 8% at design rates and no more than 15% at turndown rates. Special designs are available for many INTALOX distributors that will result in even lower flow variation. Turndown ranges for various distributor models are given in the description of each distributor.

Koch-Glitsch traditional distributors allow greater flow variations than INTALOX distributors and typically are rated for a broader range of operation. For high turndown requirements, multiple orifice levels or slotted weirs may be used with some INTALOX distributor designs as well as traditional distributor styles. When these metering styles are used, the flow variation will be higher through part of the operating range than with a single level orifice. In many cases, the higher flow variation will exceed the limits for an INTALOX distributor.

Approximate Orifice Size for Gravity Flow Distributors

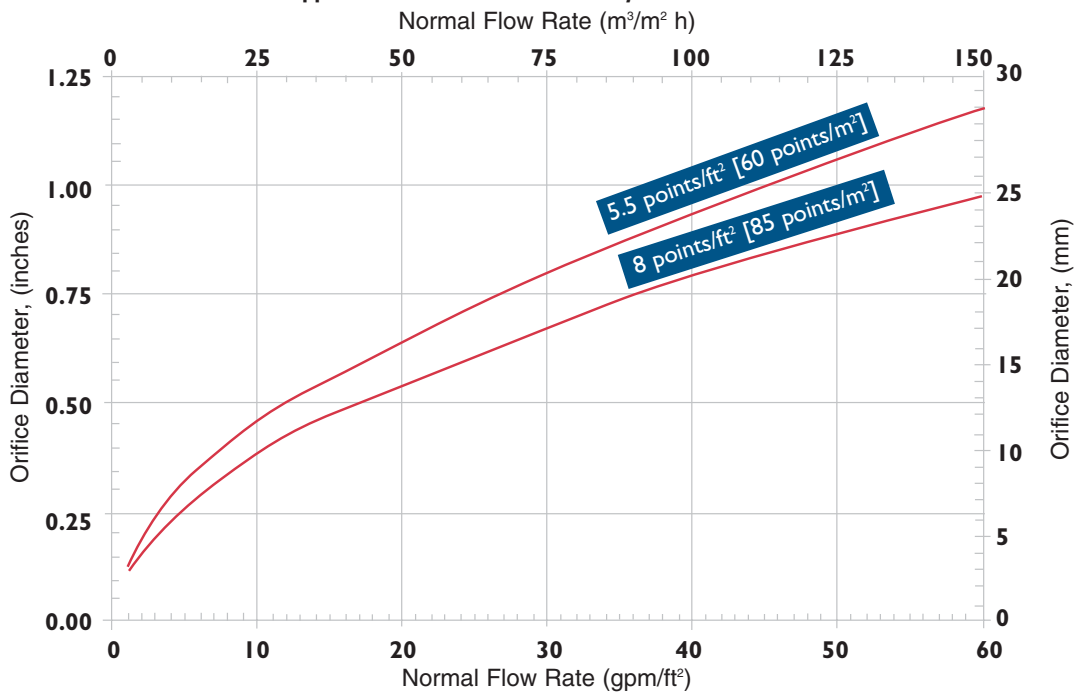

Model TP206, TS206 INTALOX® Pan Distributor (Model TP207/TS207 Redistributor)

- ▶ Diameters 10 - 48 in. [250 – 1200 mm]
- ▶ Liquid rates above 0.5 gpm/ft² [1.25 m³/m² h]
- ▶ Attached to clips or suspended from a ledge

Distribution points are arranged to provide optimum distribution quality, with gas risers positioned between the distribution points. Small diameter pans may not have gas risers because gas passage is provided in the gap between the pan and the vessel wall.

The Model 206 distributor uses standard pan-bottom distribution orifices or optional liquid conductor tubes passing through the pan floor. When conductor tubes are used, the metering orifices are located in the side of the tube, usually well above the pan floor.

Conductor tubes provide two benefits:

- Fouling resistance by allowing debris to settle in the bottom of the pan without clogging the raised orifices.
- Wide turndown ratio by utilizing orifices at two or three levels.

At high flow rates, the large bottom orifices of the standard Model 206 do not tend to foul. At lower flow rates, the smaller orifices may be prone to fouling, and the conductor tube option should be considered. Refer to the chart on page 4 to estimate an orifice size for your liquid rate, and to assess whether fouling is a concern for the bottom orifices. For example, if you need a distributor to flow between 60% and 120% of a normal flow rate of 4 gpm/ft² (10m³/m² h), you will need an approximate 0.25 in. (6 mm) diameter orifice. If the orifice size will foul in the bottom of the liquid distributor, choose the conductor tube option.

The turndown ratio of the standard pan-bottom orifice is 2.2:1. The optional conductor tubes can expand this ratio up to 8:1 with multi-level orifices.

Construction Details

The Model 206 is bolted to clips (standard) or suspended from a ledge located between body flanges (optional). Setting the distributor on a ledge is not recommended.

All joints in multi-piece pans are gasketed.

In towers with smaller than 24 in. [600 mm] IDs, one-piece construction for installation through a body flange is the standard.

The standard design for a Model 207 redistributor includes gas riser covers and gasket wall wiper.

Design Options

- Conductor tubes rather than bottom orifices.
- Body flange mounted support ledge (Model 206)
- Suspended mounting
- Non-standard point count
- Multi-piece construction for tower IDs smaller than 24 in. [600 mm]
- Special gasketing material

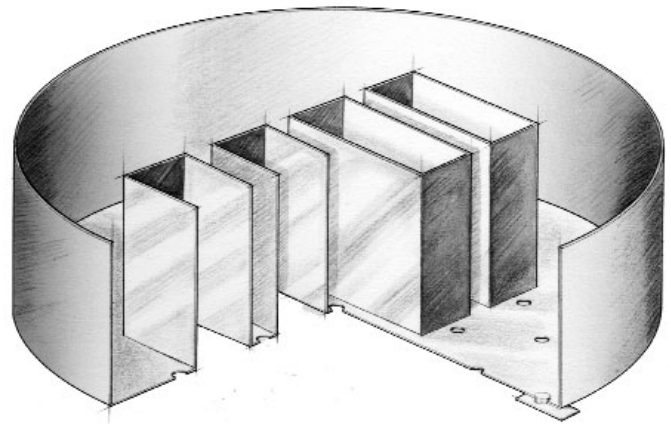

Model TP236, TS236 INTALOX® Channel Distributor (Model TP237, TS237 Redistributor)

- ▶ Diameters larger than 36 in. [900 mm]
- ▶ Liquid rates between 0.5 and 12 gpm/ft² [1.25 – 30 m³/m² h]
- ▶ Flow equalization passages
- ▶ Elevated orifices
- ▶ Liquid overflow protection
- ▶ Fouling resistant

The Model 236 distributor features channel construction and distribution orifices in channel walls or liquid conductor tubes. It performs like the Model 276 distributor with conductor tubes, but it also includes liquid cross-flow between channels.

The Model 236 distributor is useful when column vertical space is limited and there is insufficient room for the taller Model 276. The liquid cross-flow also allows a useful redistributor form in the Model 237.

Construction Details

The Model 236/237 is installed on a full support ledge (standard) or is suspended from beams (optional). All joints are gasketed.

The standard design for a Model 237 redistributor includes a wall wiper on the support ledge for the support above and gas riser covers to collect and redistribute liquid raining down from above.

Design Options

- Non-standard point count
- Multiple level orifices (for high turndown ratio)
- Leveling shims
- Special gasket material
- Suspended from beams

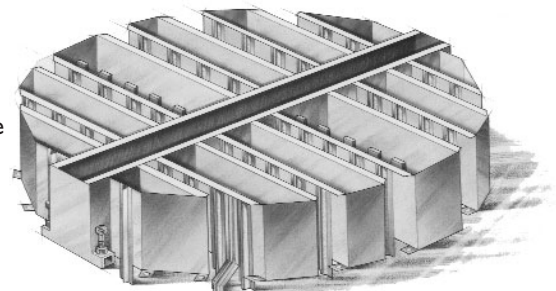

Model TP276, TS276 INTALOX® Trough Distributor

- ▶ Diameters larger than 36 in. [900 mm]
- ▶ Liquid rates above 0.5 gpm/ft² [1.25 m³/m² h]

Distribution points are positioned to optimize distribution quality. Vapor passage is provided by space between the troughs.

The Model 276 distributor uses standard trough-bottom distribution orifices or optional liquid conductor tubes passing through the trough floor. When conductor tubes are used, the metering orifices are located in the side of the tube, usually well above the pan floor.

Conductor tubes provide two benefits:

- Fouling resistance by allowing debris to settle in the bottom of the pan without clogging the raised orifices.
- Wide turndown ratio by utilizing orifices at two or three levels.

At high flow rates, the large bottom orifices of the standard Model 276 do not tend to foul. At lower flow rates, the smaller orifices may be prone to fouling, and the conductor tube option should be considered. Refer to the chart on page 4 to estimate an orifice size for your liquid rate, and to assess whether fouling is a concern for the bottom orifices. For example, if you need a distributor to flow between 60% and 120% of a normal flow rate of 4 gpm/ft² (10 m³/m² h), you will need an approximate 0.25 in. (6 mm) diameter orifice. If the orifice size will foul in the bottom of the liquid distributor, choose the conductor tube option.

The turndown ratio of the standard trough-bottom orifice is 2.2:1. The optional conductor tubes can expand this ratio up to 8:1 with multi-level orifices.

Construction Details

The Model 276 is installed on a full support ledge (standard) or is suspended from beams or clips (optional).

The Model 276 troughs are continuous across the column diameter and are fed with one or more parting boxes. No gaskets are required to seal the distributor.

Design Options

- Conductor tubes rather than bottom orifices
- Non-standard point count
- Suspended from beams or clips
- Higher turndown ratio

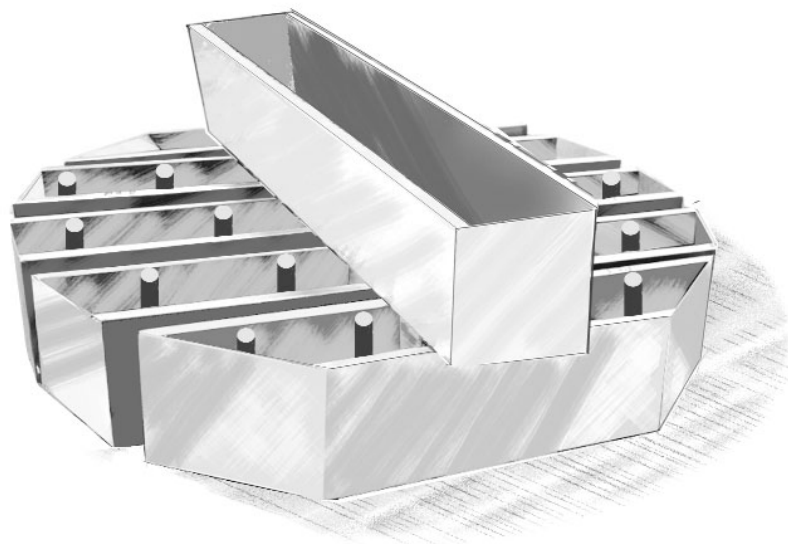
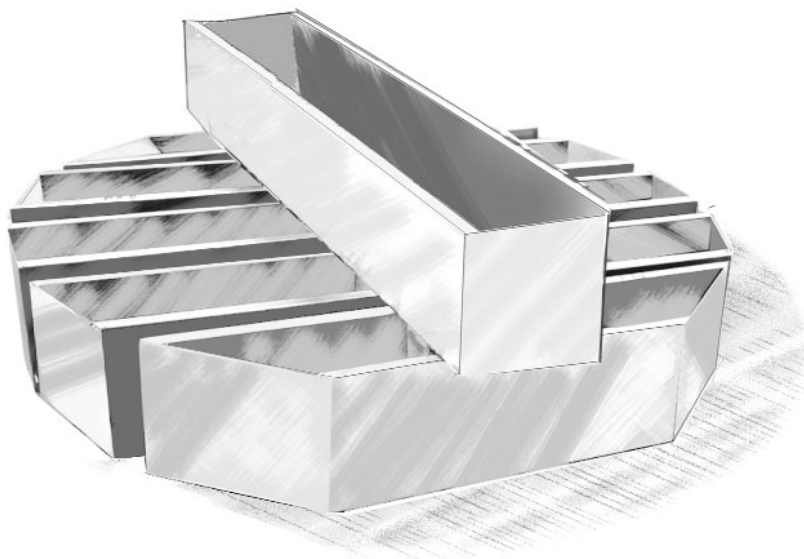

Model TP905, TS905 Weir Riser Pan Distributor

- ▶ Diameters 12 to 48 in. [300 to 1200 mm]
- ▶ Liquid rates between 1 and 8 gpm/ft² [2.5 – 20 m³/m² h]
- ▶ Weir in risers

The Model 905 pan distributor is used for highly fouling service in towers up to 48 in. [1200 mm] ID. Cylindrical risers with "V" notched weirs act as liquid downcomers as well as vapor risers. The weirs provide a high turndown ratio on liquid; however, the vapor capacity is limited. Also, high vapor flows reduce the liquid capacity and increase liquid entrainment because of the countercurrent flow in the small risers.

Distributors 19.4 in. [500 mm] and smaller are one-piece construction and are installed through a column body flange as the standard. Special multi-piece construction can be supplied. Larger sizes are multi-piece as the standard. Multi-piece pan sections are designed to pass through the vessel manway for installation.

Construction Details

The Model 905 is supported by a full ledge or by lugs. Gasketed joints are standard for multi-piece pans.

Design Options

- One-piece construction for body flange mounting
- Multi-piece construction on 19.4 in. [500 mm] ID and smaller
- Special gasketing material
- Slotted weirs for low flows

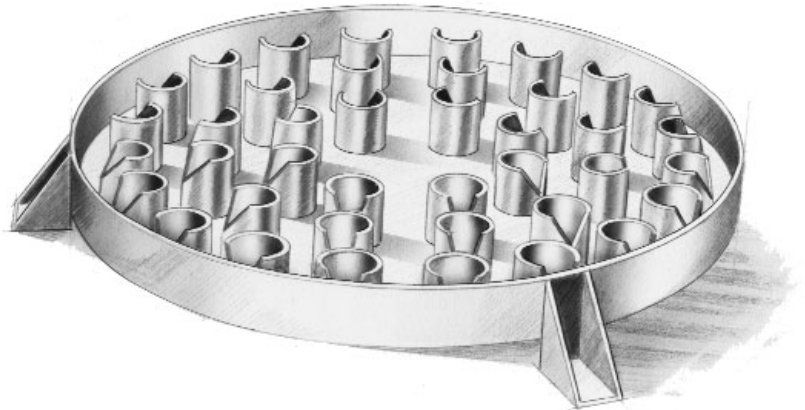

Model TP906, TS906 Pan Distributor

- ▶ Diameters up to 48 in. [1200 mm]
- ▶ Liquid rates between 1 and 30 gpm/ft² [2.5 – 75 m³/m² h]
- ▶ Orifices in bottom

The Model 906 pan distributor uses bottom orifices for liquid metering/distribution. Larger diameter distributors include circular gas risers. Vapor passage is between the pan rim and the tower wall, and through the gas risers when included.

The standard turndown range is 2.5:1.

Distributors 19.4 in. [500 mm] and smaller are one-piece construction and are installed through a column body flange as the standard. Special multi-piece construction can be supplied. Larger sizes are multi-piece as the standard. Multi-piece pan sections are designed to pass through the vessel manway for installation.

Construction Details

The distributor is supported by a full ledge or by lugs. Gasketed joints are standard for multi-piece pans.

Design Options

- One-piece construction for body flange mounting
- Multi-piece construction on 19.4 in. [500 mm] ID and smaller

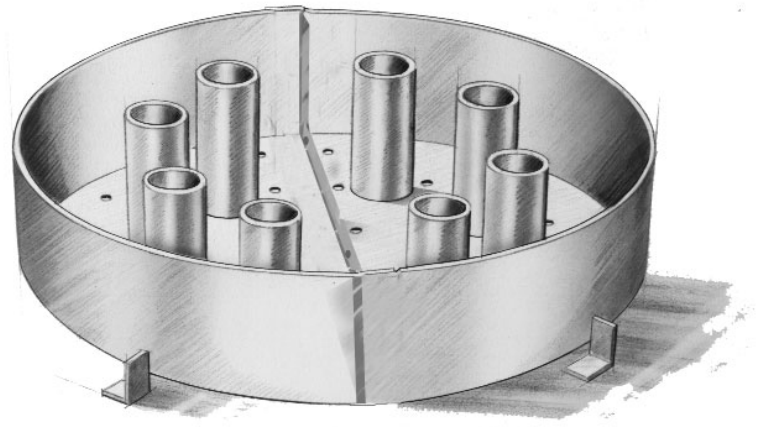

Model TP985, TS985 Weir Trough Distributor

- ▶ Diameters larger than 36 in. [915 mm]
- ▶ Liquid rates between 2 and 40 gpm/ft² [5 – 100 m³/m² h]
- ▶ Weirs in troughs
- ▶ Fouling resistant

The Model 985, a weir-trough distributor, is effective for handling high liquid flow rates in towers with moderate to severe fouling services. The distributor is supplied in towers larger than 36 in. [915 mm] ID.

Model 985 distributors that are designed for the highest flow rates use triangular weirs, also called "V" weirs. If fouling is not severe, distributors that are designed for lower flow rates use slotted weirs for better flow control. Vapor passage is provided by the space between troughs.

Liquid is metered to the closed-end troughs by one or more parting boxes. The standard turndown ratio is 2.5:1. Higher turndown ratios can be achieved with special parting box design.

Standard designs require 16.2 in. [410 mm] ID manways. Special turndown ratio designs with slotted weirs in parting boxes will require 18.7 in. [475 mm] ID manways.

Construction Details

The Model 985 is installed on a full support ledge (standard), or suspended from beams (optional).

No gaskets are required.

Design Options

- Higher turndown ratio with slotted weirs in metering boxes
- Suspended from beams
- Ledge clamps (thermoplastic or metal)

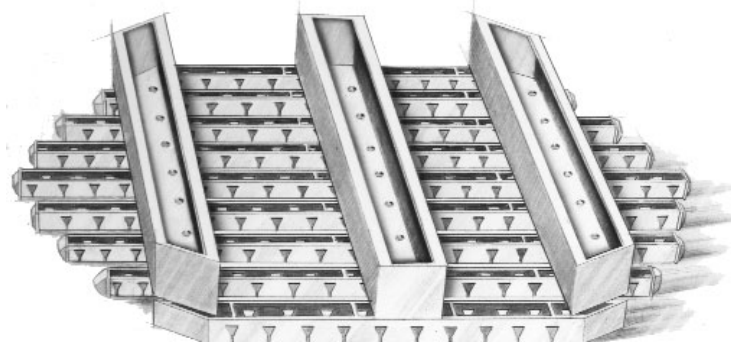

Model TP916, TS916 Deck Distributor (Model TP917/TS917 Redistributor)

- ▶ Diameters larger than 12 in. [300 mm]
- ▶ Liquid rates between 2 and 50 gpm/ft² [5 – 125 m³/m² h]
- ▶ Orifices in deck

The deck-type construction balances the liquid level over the distributor. Vapor passage is provided through long, rectangular gas risers.

The Model 916 distributor provides minimal fouling resistance at lower liquid rates because the distribution orifice diameters get smaller. A trough-type distributor with sidewall orifices, such as Model 986, should be considered as an alternative.

The deck sections are designed to pass through the vessel manway for installation. The maximum turndown range of flow is determined by the size of the manway access. The standard turndown range is 2.2:1.

In columns 24 in. [610 mm] ID or smaller, one-piece construction is standard and requires installation through a body flange. As an option, a special multi-piece construction is available.

Construction Details

The distributor is installed on a support ledge and secured with tray clamps. Thermoplastic clamps are standard on TS models. PP clamps are standard on TS models.

The standard design for a Model 917 redistributor includes gas riser covers to collect liquid raining from above.

Both models use gaskets as the standard. On small, one-piece construction, the plate is sealed to the tower wall with rope packing as the standard.

Design Options

- Higher turndown ratio
- Body flange mounting (small diameter only)
- Elevated orifices in tubes
- Slotted weirs in tubes
- Multi-piece construction for 24 in. [610 mm] ID or smaller
- Tray clamps (metal or non-standard thermoplastic materials)

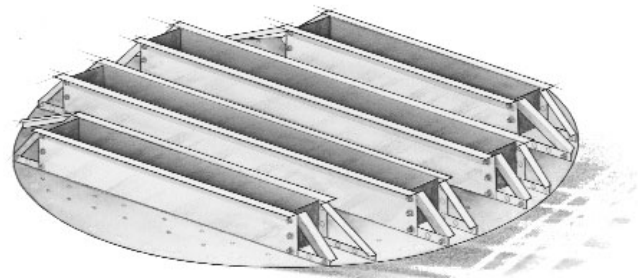

Model TP976, TS976 Trough Distributor

- ▶ **Diameters larger than 36 in. [915 mm]**
- ▶ **Liquid rates between 2 and 40 gpm/ft² [5 – 100 m³/m² h]**
- ▶ **Orifices in troughs**
- ▶ **Limited fouling resistance**

The Model 976 is a versatile, general-purpose liquid distributor that performs well at high liquid rates. It is both inexpensive and easy to install.

In cases in which the extreme fouling resistance of the Model 985 is not needed, the Model 976 is a good choice for its better distribution quality. Refer to the approximate orifice sizing chart on page 4 to determine whether the Model 976 can be used instead of a Model 985.

Orifices are located in the base of the troughs. Vapor passage is provided by the space between the troughs.

The trough-type construction allows easy liquid sealing and distributor leveling. Troughs are fed with one or more parting boxes. The metering boxes have large orifices, which meter the liquid to individual troughs. For high liquid rates in a large diameter column, the Model 976 uses two or three parting boxes.

The standard turndown range is 2.2:1, but distributors designed for lower liquid rates can sometimes reach 2.5:1.

Standard designs require 16.2 in. [410 mm] ID manways. Special turndown ratio design with slotted weirs in metering boxes will require larger manways.

Construction Details

The Model 976 is installed on a full support ledge (standard) or is suspended from beams (optional). It does not require sealing.

For redistribution between packed beds, a separate liquid collector is required to collect the liquid from the bed above and feed it to the metering trough.

No gaskets are required.

Design Options

- Level shims
- Suspended from beams
- Ledge clamps (thermoplastic or metal)

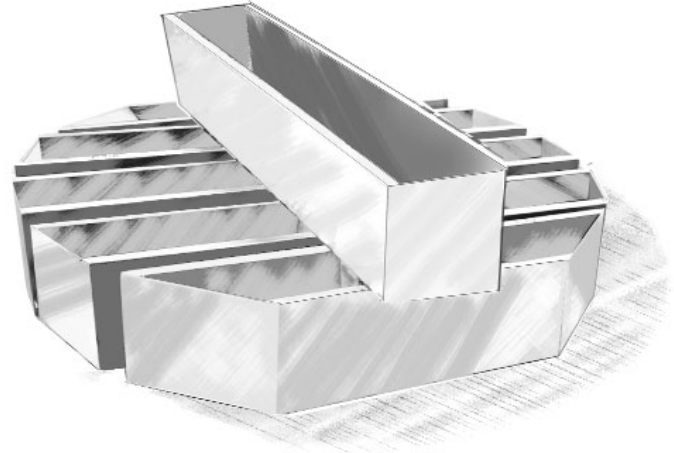

Model TP941, TS941 Pipe-Arm Distributor

- ▶ **Diameters larger than 17 in. [430 mm]**
- ▶ **Liquid rates between 1.5 and 10 gpm/ft² [4 – 25 m³/m² h]**
- ▶ **Limited fouling resistance**
- ▶ **Orifices in pipe**

The Model 941 pipe-arm distributor requires little column elevation to accomplish its distribution task, and provides high open area for high vapor flow. This distributor uses orifices to meter the liquid onto the bed and should be used only with clean liquids or with a filter designed to remove any particles that could block the orifices.

The standard design of the Model 941 handles liquid rates up to 10 gpm/ft² [25 m³/m² h], but special designs can handle higher rates. The normal turndown ratio for the Model 941 is 2.5:1. The laterals are removable to permit passage through vessel manways.

Construction Details

The header section is flanged for standard horizontal feed from the side of the tower. The laterals are flange connected on TS models and pipe threaded on TP models.

Inlet flange connects to an internal flange with a 150# bolt pattern as the standard. The end of the header opposite the flange connection is attached to a clip for support. Support clips, as required, are used to support the laterals. All support clips are part of the vessel and are not supplied as the standard. Beams can be used to support large distributors when needed.

Design Options

- Flanged laterals (standard on TS model)
- Vertical-feed header on tower centerline
- Threaded header (on TP model only)
- Support clips
- Support beams



Model TP943, TS943 Spray-Type Liquid Distributor

- ▶ **Diameters 8 in. [200 mm] and larger**
- ▶ **Liquid rates between 0.2 and 50 gpm/ft² [0.5 – 120 m³/m² h]**
- ▶ **Spray nozzle**
- ▶ **Good fouling resistance at medium to high flow range**

The Model 943 spray-type distributor can be designed for very low liquid rates because each spray nozzle covers a large area of the tower. Each nozzle passes a reasonable flow, even at low irrigation rates.

For most applications, the standard design uses full cone spray nozzles of 30° to 120° angles on triangular patterns. The laterals are removable for manway passage. The turndown ratio is 2:1. Higher turndown ratios may cause excessive liquid entrainment.

Material selection is limited on nozzle materials. FRP nozzles are not available. Specify a thermoplastic or metal nozzle material when ordering TS models.

Construction Details

The header section is flanged for standard horizontal feed from the side of the tower. The laterals are flange connected on TS models and pipe threaded on TP models.

Inlet flange connects to an internal flange with a 150# bolt pattern as the standard. The end of the header opposite the flange connection is attached to a clip for support. Support clips, as required, are used to support the laterals. All support clips are part of the vessel and are not supplied as the standard. Beams can be used to support large distributors when necessary.

Design Options

- Flanged laterals (standard on TP models)
- Vertical-feed header on tower centerline
- Threaded header (on TP models only)
- Support clips
- Support beams
- Bayonet headers for single nozzle distributors
- Special inlet flange

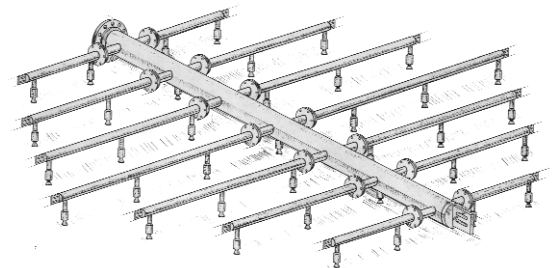

Model TP219, TS219 INTALOX® Liquid-Only Feed Pipe

▶ Liquid-only feed to INTALOX® liquid distributors

The Model 219 is a liquid-only, metered feed pipe that is used to supply liquid from outside a column onto a Koch-Glitsch INTALOX distributor or redistributor. The liquid must contain less than 1% vapor by volume.

The Model 219 feed pipe regulates liquid flow through a system of headers, lateral branches, and downpipes to one or more feed areas on the distributor. This system minimizes turbulence and horizontal flow velocities in the distributor.

A Model 219 that feeds directly onto a distributor at the final distribution level is limited to a turndown ratio of approximately 2:1. Higher turndown ratios are attained by using distributors with parting boxes or adding a pre-distributor between the distributor and the Model 219 feed pipes.

Construction Details

For the Model 219 feed pipe, standard construction includes the following:

- The inlet flange mates to an internal flange with a 150# flange bolt pattern.
- The end of the header opposite the inlet is attached to wall clips, which are part of the tower wall.
- All connections on TS models are flanged with thermoplastic bolting.
- Connections for TP models are threaded for pipe diameters up to 2½ in. [65 mm] and flanged for diameters larger than 2½ in.
- Designs with lateral flanges include gasketing.

Design Options

- All-flanged construction for TP Models for pipe diameters 2½ in. [65 mm] and smaller
- Wall clips
- Support beams

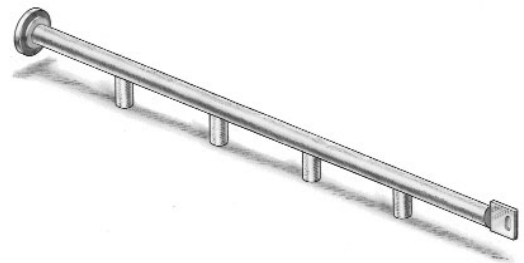

Model TP719, TS719 Liquid-Only Feed Pipe

▶ Liquid-only feed to traditional liquid distributors

The Model 719 is a liquid-only, metered feed pipe that is used to supply liquid from outside a column onto a traditional distributor or redistributor. The liquid must contain less than 1% vapor by volume.

The Model 719 feed pipe regulates liquid flow through a system of headers, lateral branches, and downpipes to one or more feed areas on the distributor. This system minimizes turbulence and horizontal flow velocities in the distributor.

A Model 719 that feeds directly onto a distributor at the final distribution level is limited to a turndown ratio of approximately 2.5:1. Higher turndown ratios are attained by using distributors with parting boxes or adding a pre-distributor between the distributor and the Model 719 feed pipes.

Construction Details

For the Model 719 feed pipe, standard construction includes the following:

- The inlet flange mates to an internal flange with a 150# flange bolt pattern.
- The end of the header opposite the inlet is attached to wall clips, which are part of the tower wall.
- All connections on TS models are flanged with thermoplastic bolting.
- Connections for TP models are threaded for pipe diameters up to 2½ in. [65 mm] and flanged for diameters larger than 2½ in.
- Designs with lateral flanges include gasketing.

Design Options

- All-flanged construction for TP Models for pipe diameters 2½ in. [65 mm] and smaller
- Wall clips
- Support beams

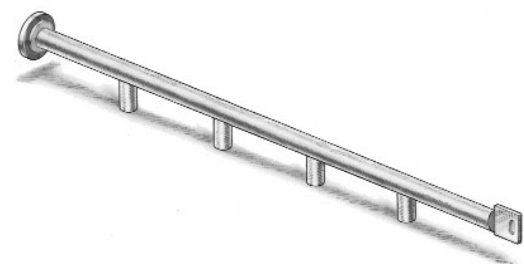

Model TP239, TS239 Liquid-Only Bayonet Feed Pipe

Bayonet feed pipes are designed to be inserted from outside a column and are used only when an internal column connection cannot be used, such as in a lined column.

Because the column "holder" nozzle in a bayoneted feed pipe is larger than the feed line size, there is usually not sufficient clearance for downpipes at the feed pipe discharge points, which limits performance. In this situation, distributors must include flow diverters and velocity reduction features.

The Model TP 239 is not recommended for Type II construction, which is shown in the diagram below. Thermoplastic construction, even with flange gussets, will not support the pipe load that will be transferred on the outside of the column. Type II construction is not supplied in PTFE for structural reasons.

Construction Details

Type I construction, illustrated in the diagram below, is provided with a flat face on both sides of the flange with a flange OD equal to the inside of the bolt circle as the standard. The flange is placed between the external pipe flange and column nozzle, which are supplied by a third-party vendor. Full flange OD with bolt holes is an option.

Type II construction is provided with flat flange faces. The flanges provide bolt size and patterns as specified. The flange spacing allows the nut side of the bolts to be located between the flanges unless otherwise specified. Flange gussets are included between the flanges for additional strength and stiffness.

Gasketing is not supplied in standard construction.

Design Options

- Full OD flange and bolt holes for Type I construction
- Special flange spacing for Type II construction
- Gasketing
- Orientation indicator on flange

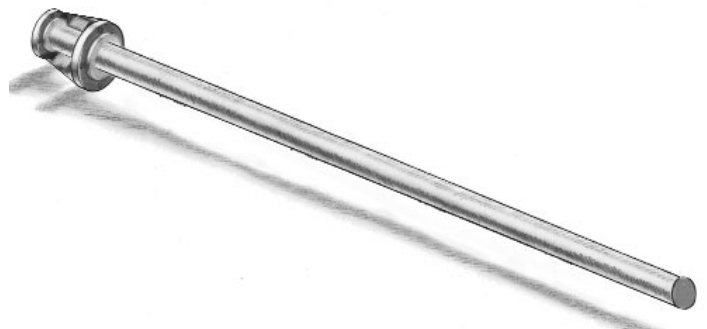
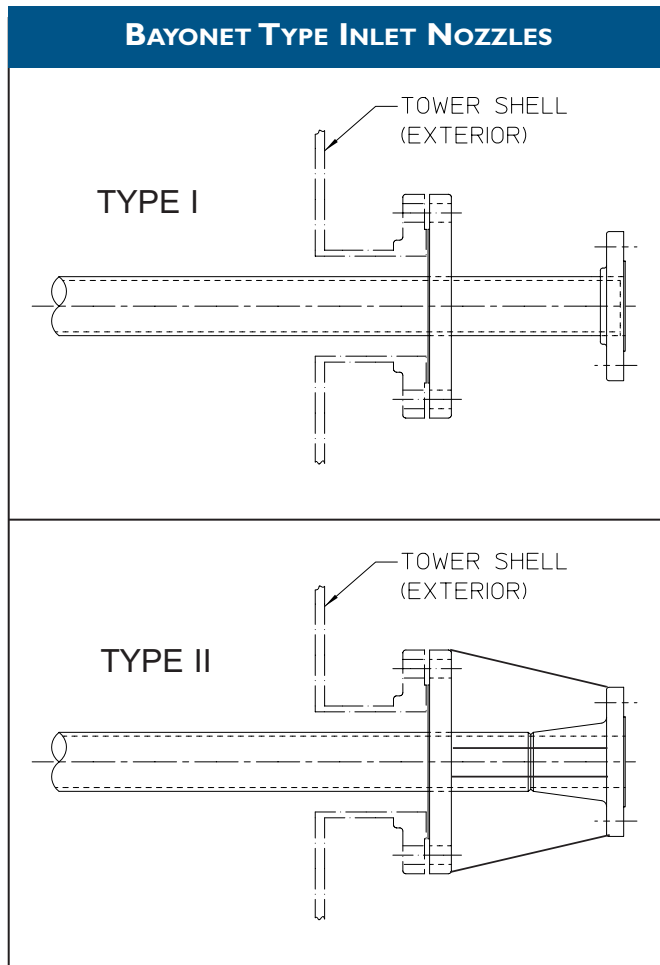

Bed Limiters

Random Packing

A packing retention device, such as a bed limiter or anti-migration bar, confines packing movement and is recommended whenever there is the potential for sufficient vapor load to fluidize the top of a packed bed during upset or flooding conditions. The retention device serves two purposes:

- To prevent packing from being lifted into the liquid distributor, which would reduce its performance.
- To keep the bed level. A non-level bed promotes vapor maldistribution and may cause liquid entrainment if the packing level approaches the distributor.

Only a non-interfering bed limiter design, which attaches to either the column wall or rests on top of the packing and is retained by the distributor above, should be used with INTALOX distributors.

Structured Packing

Bed limiters for structured packing are recommended only when there is the potential for packing displacement during upset or flooding conditions. If columns operate at a low pressure drop with a low percentage of flood and are not prone to sudden vapor surges, bed limiters are not needed.

In cases where upset conditions are not a concern, a bed limiter resting on the structured packing can be used as a support for a trough or pan distributor.

Columns with INTALOX distributors should only use non-interfering bed limiters.

Model TP803, TS803 Bed Limiter for Structured Packing

- ▶ **All column diameters**
- ▶ **Minimizes interference of liquid distributors**

The Model 803 bed limiter is designed for use with plastic structured packing. It is bolted to vertical wall clips in large diameter towers. The Model 803 is integrated with the liquid distributor when restricting small diameter, one-piece packing layers.

Construction Details

Standard construction will withstand variable upward force, depending on the span in the column and process operating temperature.

The bed limiter is designed to pass through available vessel manways for installation.

Design Options

- Greater uplift resistance than the standard

Model TP805 Bed Limiter for Random Packing

- ▶ All column diameters
- ▶ Minimizes interference of INTALOX® liquid distributors

The Model 805 bed limiter is expandable to permit contact with the vessel wall, which prevents random packing from passing through and eliminates the need for wall attachments.

The bed limiter is designed to pass through available vessel manways for installation.

Construction Details

Standard construction will withstand variable upward force, depending on the material of construction of the bed limiter, span in the column, and process operating temperature.

Design Options

- Greater uplift resistance than the standard

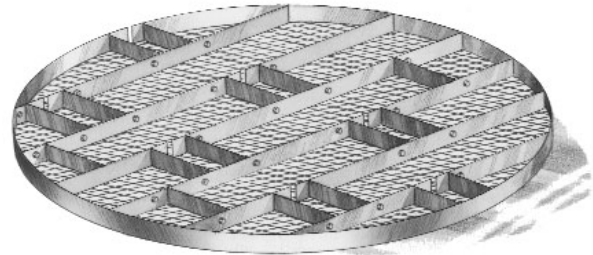

Model TP825, TS825 Bed Limiter for Random Packing

- ▶ Diameters 11.5 in. [291 mm] and larger
- ▶ Fastens to vessel wall

The Model 825 bed limiter is used with most random packing when traditional liquid distributors are used. It mounts to a vessel ledge using clamps.

Sections are designed to pass through the vessel manways.

Construction Details

Standard construction will withstand variable upward force, depending on the material of construction of the bed limiter, span in the column, and process operating temperature.

The TS model is constructed with FRP framing, thermoplastic screen and ledge clamps to provide the high open area necessary for countercurrent liquid and gas capacities.

Design Options

- Greater uplift resistance than the standard
- Clip mounted to vessel (eliminates ledge clamps)



Support Plates

Every packed bed needs a support plate that:

- Physically retains and supports the packed bed, including packing, liquid hold-up, and any trapped solids during operating conditions.
- Has a high percentage of open area to allow unrestricted countercurrent flow of liquid and vapor.

Supports are designed to handle the flow rates, which are specified at the time of order placement, without limiting the capacity of the packing they retain.

Structured packings, because of the integral nature of the packing itself, allow support by a simple, open-grid structure.

Random packings use a gas-injection support that provides separate passages for liquid and vapor flow so the two phases do not compete for the same opening. Packing elements are retained with specific slot openings while the contour of the support provides a high percentage of open area.

Model TP814 , TS814 Random Packing Gas Injection Support

- ▶ **Diameters 6 to 48 in. [150 to 1200 mm]**
- ▶ **Gas injection design**

The Model 814 support combines a high percentage of free area with excellent mechanical strength. Plates are one piece for columns up to 12 in. [300 mm] ID. Larger diameters use two-piece, three-piece, or four-piece construction.

Construction Details

This support rests on a full vessel ledge. Ledge strength calculations must be provided by the customer or a third-party, such as the vessel supplier.

Columns with larger diameters may require the use of midspan beams depending on the material of construction of the support, design load, and process operating temperature.

Design Options

- One-piece construction for larger diameters
- Beams clamped to ledge or hold-down beam clamp assembly

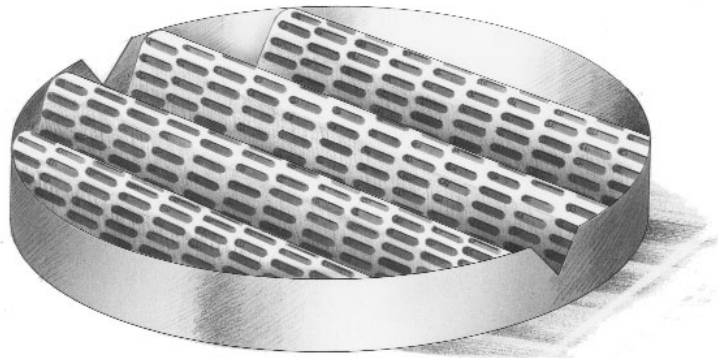

Model TP804, TS804 Random Packing Gas-Injection Support

- ▶ Diameters larger than 36 in. [900 mm]
- ▶ Gas injection design

Each Model 804 support is designed to retain the desired packing under the specified operating conditions without limiting the packing capacity. Therefore, beam height, material thickness and slot size will vary depending on packing size, bed weight and process conditions.

All beams are designed to pass through a manway 16 in. [406 mm] or larger as the standard.

Construction Details

The support rests on a full column ledge. Ledge strength calculations must be provided by the customer or a third party, such as the vessel supplier.

Columns with larger diameters may require the use of midspan beams depending on the material of construction of the support, design load, and process operating temperature.

Design Options

- Beam-to-beam bolting
- Beams clamped to ledge or hold-down beam clamp assembly

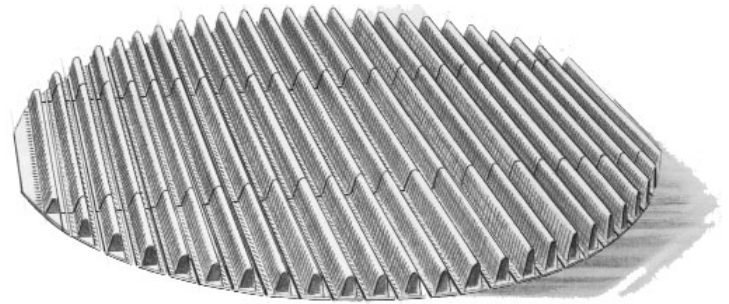

Model TP802, TS802 Structured Packing Support

- ▶ All column diameters
- ▶ Supports all plastic structured packings

The open, grid-type structure of the Model 802 allows free and uniform passage of the liquid and vapor so packing capacity is not limited.

One-piece supports are usually supplied for smaller columns that have body flange access. All other supports are supplied for installation through vessel manways.

Grid sections are bolted together but are not clamped to the ledge as the standard. TS construction utilizes thermoplastic fasteners.

Construction Details

For very small diameter columns, the support rests on lugs. For all other columns, the support rests on a full column ledge. Ledge strength calculations must be provided by the customer or a third party, such as the vessel supplier.

Midspan beams may be required, depending on column diameter, design load, and temperature requirements.

Design Options

- Ledge clamps (thermoplastic or metal)

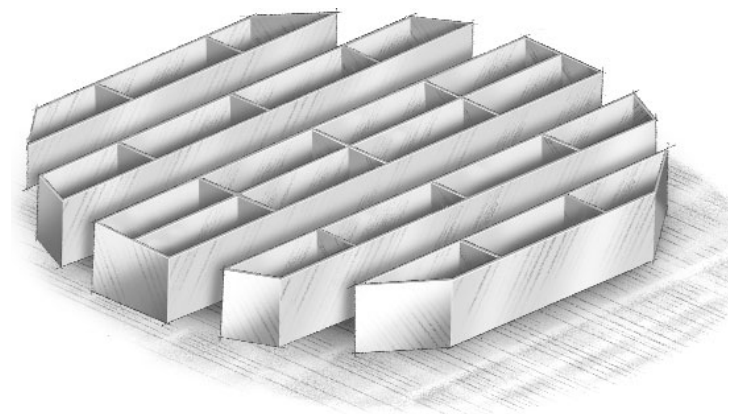

Model TS834/TS844 Random Packing Gas-Injection Support

- ▶ **Model TS834 - Diameters 18 to 48 in. [450 to 1220 mm]**
- ▶ **Model TS844 - Diameters 45 in. [1145 mm] and larger**
- ▶ **Gas injection design**

The Model TS834/TS844 support is designed to retain #2 [50 mm] Super INTALOX Saddles, 1 in. [25 mm] FLEXIRING, #2 BETA RING, INTALOX SNOWFLAKE, and CMR #2A or larger plastic packings. Smaller size packings require larger packings placed on the support or special design plates.

TS834 beams are designed to pass through a 7.5 in. [190 mm] or larger hand-hole. TS844 beams are designed to pass through a 17 in. [430 mm] or larger manway.

Refer to the chart below to determine whether a column will need midspan support below the Model 834 or 844.

Construction Details

The Model TS834/TS844 support rests on a full vessel ledge. Ledge strength calculations must be provided by the customer or a third party, such as the vessel supplier.

Columns with larger diameters require the use of midspan beams depending on the material of construction of the support, design load, and process operating temperature.

Design Options

- Hold-down beam clamp assembly (thermoplastic or metal fasteners)
- Embedded reinforcing bars

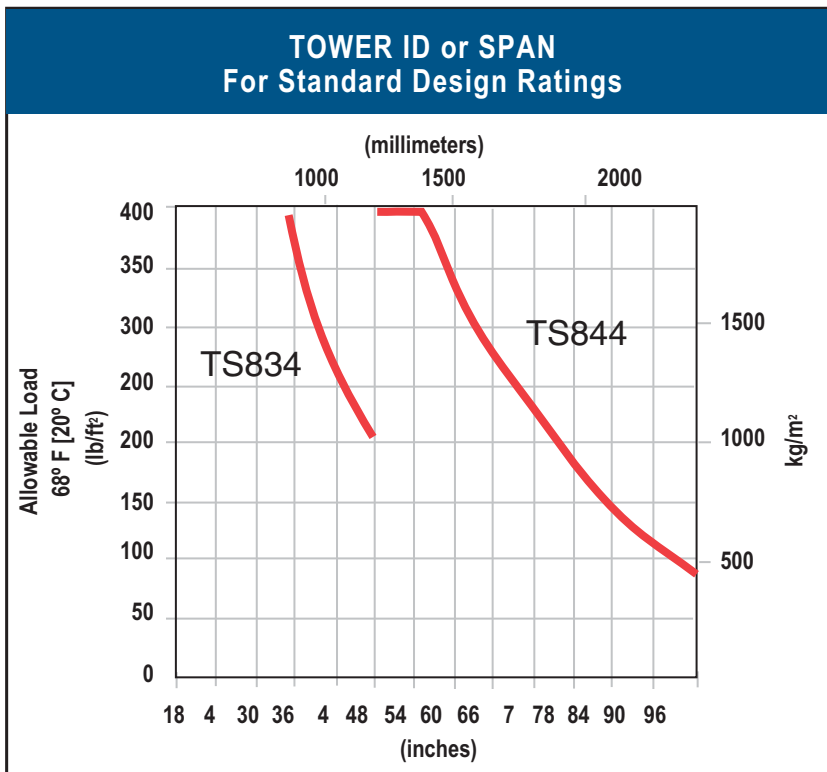
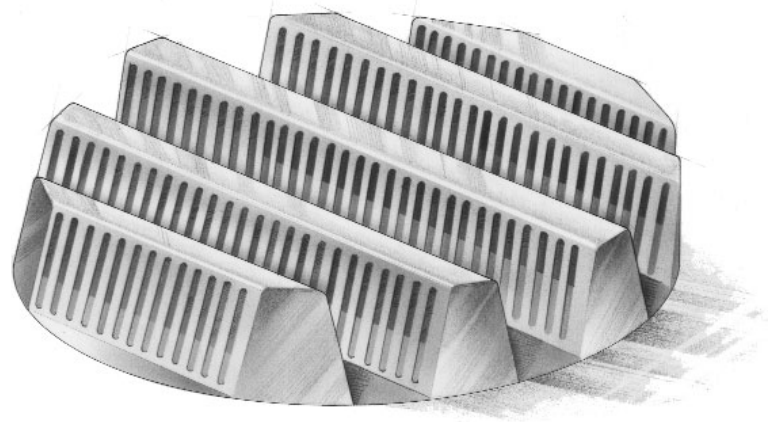

ALLOWABLE LOAD CORRECTION MULTIPLIER	
Temperature °F [°C]	Multiplier
100 [38]	0.948
125 [52]	0.908
150 [66]	0.867
175 [80]	0.827
200 [93]	0.787
225 [107]	0.746
250 [121]	0.706

Model TP854, TS854 Heavy-Duty Random Packing Gas-Injection Support

- ▶ **Diameters 10 in. [254 mm] and larger for Model TP854**
- ▶ **Diameters 18 in. [460 mm] and larger for Model TS854**
- ▶ **Gas injection design**
- ▶ **Heavy-duty construction**

Each Model 854 is designed to retain the desired packing under the specified operating conditions without limiting the packing capacity. The height, material thickness and slot size of the support will vary depending on the packing size, bed weight and process conditions.

This model provides all necessary hydraulic capabilities and much greater bed load capacities. The height will vary with shorter supports for small columns and taller supports on larger columns.

Small diameter supports can be bolted together outside the column or supplied as one piece for insertion through a column body flange. For larger diameter columns, supports are designed to pass through a manway 16 in. [406 mm] ID or larger as the standard.

Model TP854 has fasteners of the same material as the support. Model TS854 has thermoplastic or metal fasteners; PVDF bolting is standard.

Construction Details

The support rests on a full column ledge. Ledge strength calculations must be provided by the customer or a third party, such as the vessel supplier.

Columns with larger diameters may require the use of midspan beams depending on the material of construction of the support, design load, and process operating temperature.

The Model 854 is bolted together as the standard.

Design Options

- Hold-down beam clamp assembly
- Body flange mounted

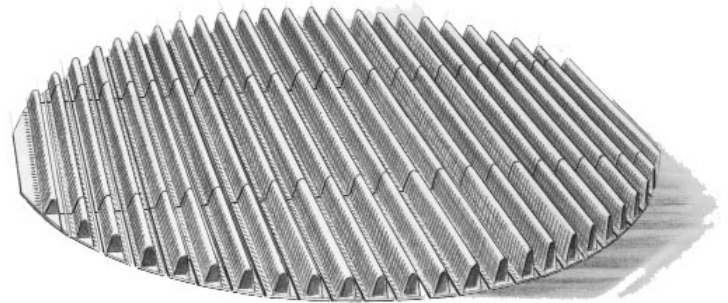

If columns require a combination of high temperature and heavy bed load, Koch-Glitsch can embed reinforcing structures in the Model 854 packing support plate to remove beam load from the thermoplastic material. These reinforcing structures can include:

- Carbon/Graphite bars
- Ceramic bars
- High-strength FRP bars
- Dual-laminate bars
- Thermoplastic bars

For this option, both the base thermoplastic material and a suitable reinforcing material must be selected by the customer or a third-party supplier. Koch-Glitsch, LP will design the support plate and reinforcement and will embed the reinforcing structures. In some cases, the support plate reinforcement will eliminate the need for midspan beams in the vessel.

Typical Column Layout

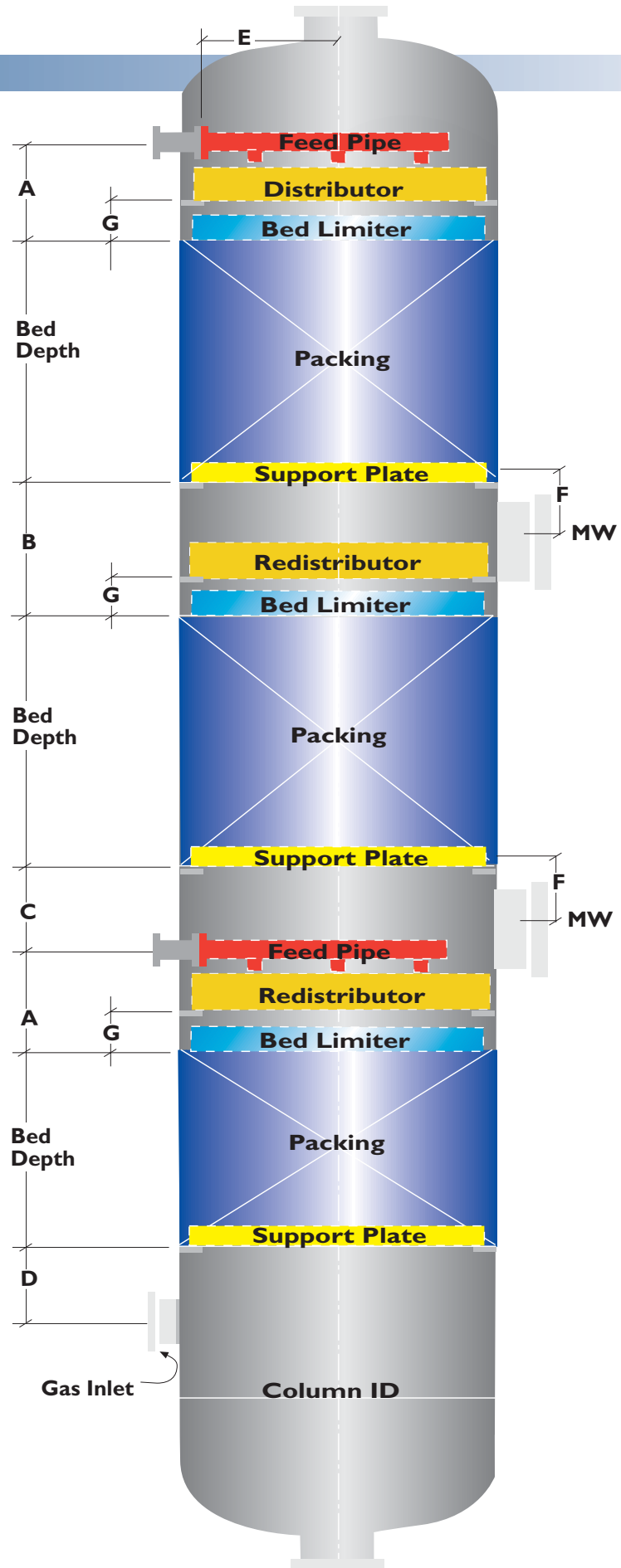
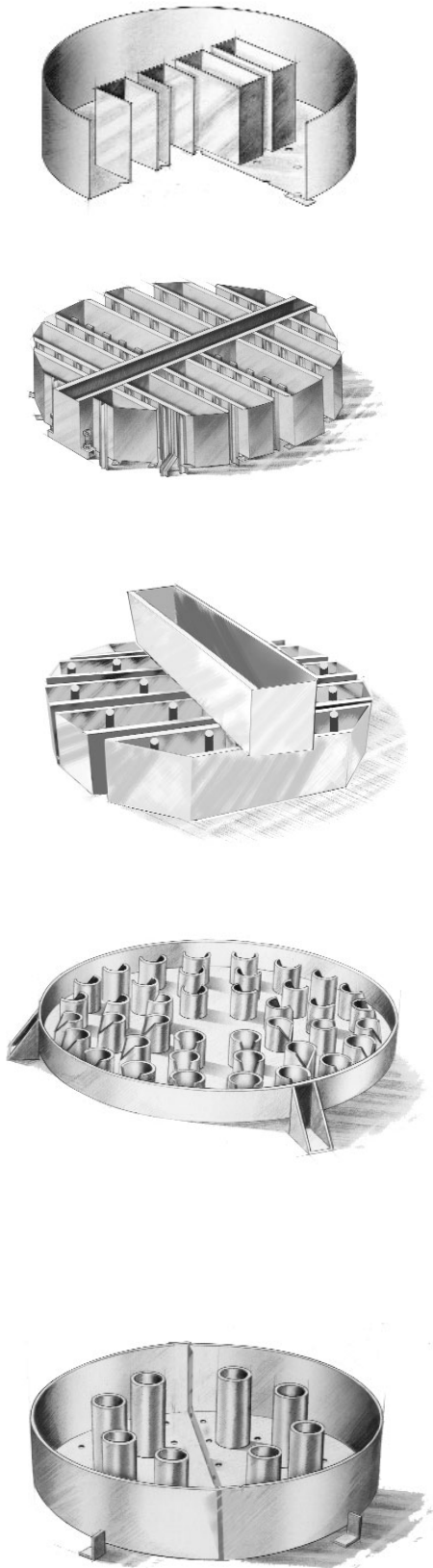

For Columns up to 28 in. [710 mm] ID

$$A = 8'' + \chi + (1/2) \times (\text{INLET})$$

OR

$$A = \chi \quad (\text{For Models 941 and 943 only})$$

$$B = 10'' + \chi + D_{MW}$$

$$C_{MIN} = 4'' + (1/2) \times (\text{INLET}) + D_{MW}$$

$$D_{MIN} = 12'' + (1/2) \times (\text{GAS INLET})$$

$$E = (1/2) \times (\text{COLUMN ID}) - 4''$$

$$F = 2'' + (1/2) \times D_{MW}$$

$$G = 6''$$

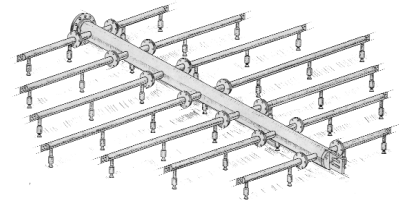
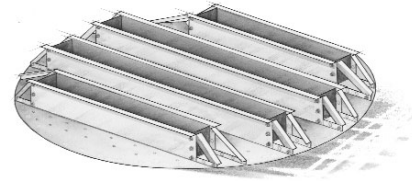

For Columns Larger than 28 in. [710 mm] ID

$$A = 10'' + \chi + (1/2) \times (\text{INLET})$$

OR

$$A = \chi \quad (\text{For Models 941 and 943 only})$$

$$B = 12'' + \chi + D_{MW}$$

$$C_{MIN} = 6'' + (1/2) \times (\text{INLET}) + D_{MW}$$

$$D_{MIN} = 12'' + \text{GAS INLET}$$

$$E = (1/2) \times (\text{COLUMN ID}) - 4''$$

$$F = 4'' + (1/2) \times D_{MW}$$

$$G = 8''$$

INLET = Nominal Liquid Inlet Diameter

GAS INLET = Nominal Gas Inlet Diameter

D_{MW} = Nominal Manway or Hand Hole Diameter

For " χ " Dimensions

MODEL NO.	χ
206	10"
207	15"
236	12"
237	17"
276	22"
286	24"
905	8"
906	11"
916	12"
917	17"
941	8"
943	Varies from 14" to 30"
976	20"
985	18"

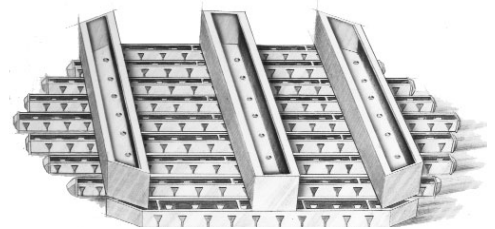

These dimensions are for rough layout purposes only.

Final flow rate, turndown ratio, and nozzle sizing may require elevation changes for proper fit and function.

Suggested dimensions apply to standard turndown ratio only.

Special Tower Internals

Koch-Glitsch offers a complete line of plastic internals, including custom designs of the internals presented in this brochure. For additional internals that can be constructed in plastic, refer to the table below. For a list of other Koch-Glitsch products and services, refer to page 22. If you have questions or need additional information, contact any of the Koch-Glitsch offices.

Feed Devices

Good tower performance requires proper handling of liquid and vapor entering the column. Column feeds generally are classified in four categories.

- Liquid only (described in this brochure)
- Mixed liquid and vapor; flashing or suppressed flash
- Vapor only
- Reboiler returns

The selection criteria for each category are unique. Internals for each category can be constructed in metal or plastic. Refer to the Koch-Glitsch brochure, KGMTIG, for descriptions of the metal internals.

Vapor Distributors

Vapor feeds to packed columns often need no-vapor distribution devices, because packing has a limited capability to distribute its own vapor. However, vapor feeds entering through undersized nozzles can have sufficient velocity head to overwhelm the natural vapor distribution capability of the packing, which may cause moderate or severe maldistribution. Ask Koch-Glitsch to check the vapor inlet size of your column when you order the column internals.

Liquid Collector Plates

Liquid collectors are used:

- Below packed beds to prepare the liquid for partial or total draw-off through a side nozzle.
- Between beds of packing to prepare the liquid for "redistribution" in a primary distributor.

Packing support and liquid collection functions can be integrated into a combination packing support plate/collector tray.

Contact Koch-Glitsch for recommendations on collector design.

Model	Old NorPro Model	Old Koch Model	Old Glitsch Model	Description
Liquid Distributors & Redistributors				
TP & TS216	116			INTALOX® orifice deck distributor
TP & TS217	117			INTALOX® orifice deck redistributor
Vapor Distributors				
TP & TS716	896		CTD-531	Deck type vapor distributor
TP & TS746	198	342	VDP-991	Pipe arm vapor distributor
Feed Devices				
TP & TS748	196			Inlet vapor diffuser
Liquid Collectors				
TP & TS611	833	501	CTD-501	Deck type with or without sump
TP & TS633	633	510,511		Chevron vane type with or without sump
Miscellaneous				
TP & TS800	100			Support ledge or segment
TP & TS810	101			Support beam
TP858	858			Wall wiper, body flange mounted
TP815	111			In-bed random packing anti-migration screen
TP & TS883				One-piece bed limiter for plastic structured packing in a body-flanged vessel

A Complete Line of Plastic Trays

Over the last fifty years, Koch-Glitsch has developed its basic sieve and valve trays into the most technologically advanced trays available and has developed a knowledge of tray dynamics that is second to none.

Koch-Glitsch supplies the following types of plastic trays:

- Bubble Cap trays
- Tunnel Cap trays
- Sieve trays
- **PROVALVE®** Valve Trays

Plastic trays are used in a wide variety of applications, such as acid stripping, gas washing, distillation of corrosive components, and gas drying using sulfuric acid. For corrosive distillations, stripping, and absorption applications, Koch-Glitsch plastic trays can be a more cost-effective solution than trays constructed of exotic metals or graphite. In addition, by combining plastic composites technology with fluoropolymer technology, plastic trays can be produced for relatively large diameter columns that operate at temperatures up to 200° C.

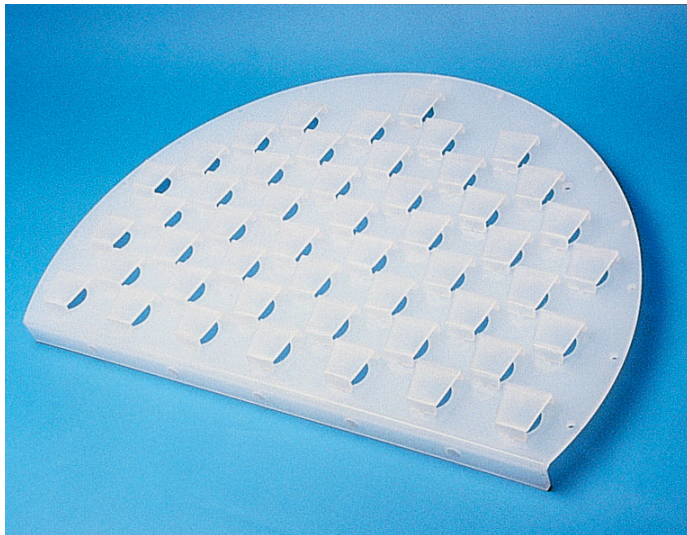

The key to the PROVALVE tray is its proprietary fixed-valve design with a uniquely tapered cover. The cover provides a forward-lateral push to the liquid across the tray, which improves liquid distribution and protects the tray deck from fouling.

PROVALVE® Valve Tray

The proprietary fixed-valve design of the PROVALVE valve tray features a uniquely tapered cover that:

- Shelters each vapor opening to effectively suppress weeping, providing high turndown capability.
- Allows a larger orifice size, which promotes lower pressure drop and protects against vapor surges.
- Deflects and directs the vapor resulting in a low, even spray height, which suppresses jet flooding and permits operation at greater vapor rates.
- Reduces fouling with its directed push that prevents liquid back flow and keeps the liquid close to plug flow. These actions eliminate areas where solids can deposit and produce a cleansing action that prevents materials from fouling the deck.

Process Characteristics

- Improved capacity over sieve trays
- Lower pressure drop than sieve trays
- Higher turndown than sieve trays
- Equal or better efficiency than conventional sieve trays
- Wider operating range than sieve trays

Mechanical Features

- Reliable, low-maintenance design
- Excellent fouling resistance
- Structural integrity
- Easy and economical installation



Cartridge Tray Construction

For smaller columns with diameters less than 42" (1066 mm), Koch-Glitsch can manufacture any type of plastic trays in cartridge-style construction. Bundles are typically 6 - 10 ft (1.8 - 3.0 m) in length, with 6 - 10 trays spaced 12 - 24" (300 - 600 mm) apart.

Koch-Glitsch Corporate Offices

Worldwide Headquarters European Offices

Koch-Glitsch, LP
P.O. Box 8127
Wichita, KS 67208-0127
4111 E. 37th Street North
Wichita, Kansas 67220
Tel: (316) 828-5110
Fax: (316) 828-5263

Koch-Glitsch Italia S.r.l.
Via Tonale 50,
Casella Postale 13
24061 Albano S. Alessandro
Bergamo, Italy
Tel: +39-035-328-611
Fax: +39-035-328-600

North American Offices

Koch-Glitsch, LP
12221 E. Sam Houston Parkway N.
Houston, Texas 77044
Tel: (713) 427-7600
Fax: (713) 427-7613

Koch-Glitsch (UK) Ltd
King Street, Fenton
Stoke-on-Trent ST4 2LT
United Kingdom
Tel: +44-1782-744-561
Fax: +44-1782-744-330

Koch-Glitsch, LP
4900 Singleton Blvd.
Dallas, Texas 75212
Tel: (214) 583-3000
Fax: (214) 583-3377

Koch-Glitsch, LP
5385 Orchardview Drive SE
East Canton, Ohio 44730
Tel: (330) 488-1279
Fax: (330) 488-1656

Koch-Glitsch Canada Co.
18 Dallas St.
Uxbridge, Ontario
L9P 1C6, **Canada**
Tel: (905) 852-3381
Fax: (905) 852-7821

Asia Offices

Koch-Asia Pacific, Inc.
7th Floor, Kss Gotanda Bldg. 21-8
Nishi Gotanda 1-chome
Shinagawa ku, Tokyo
141-8538, **Japan**
Tel: +81-3-5435-8560
Fax: +81-3-3491-3576

Koch-Glitsch Korea Co., Ltd
Dongsung Bldg. 8th Floor
17-8 Yoido-dong
Yongdungpo-ku
Seoul 150-010, Korea
Tel: +82-2-3775-2650
Fax: +82-2-780-1954

Koch-Glitsch India, Ltd
42, Kalapataru Court
G. Gidwant Marg.
Chembur, Mumbai 400074,
India
Tel: +91-22-2520-2050
Fax: +91-22-2520-2040

For a complete listing of
Koch-Glitsch offices,
visit us on the internet:
www.koch-glitsch.com

For emergencies:
[1-888-KOCH-911](tel:1-888-KOCH-911)

KOCH-GLITSCH®, INTALOX®, FLEXIRING®, CASCADE MINI-RINGS®, IMTP®,
SNOWFLAKE®, FLEXIPAC® and PROVALVE® are registered trademarks of Koch-Glitsch, LP.

Trough Distributor with Drip Tubes
Channel Distributor

U.S. Patent No. 4,909,967
U.S. Patent No. 5,597,655

DION® 382-05A - Reichhold, Inc.
DION® 6694 and DION(R) 9100 are registered trademarks of Reichhold, Inc.
DERAKANE® is a registered trademark of Dow Chemical, Inc.
HETRON® is a registered trademark of Ashland Specialty Chemical Company.
CO-REZYN® is a registered trademark of Interplastic Corporation.

NOTES:

The illustrations of column internals show one possible configuration for each internal model and are intended to demonstrate the overall function of each model. Actual internals are optimized in response to specific process conditions and may have construction details that differ from those indicated in this brochure.

The information contained in this bulletin is believed to be accurate and reliable but is not to be construed as implying any warranty or guarantee of performance.

KOCH-GLITSCH®

The Fundamental Driving Force

IN MASS TRANSFER TECHNOLOGY