

SUPERFRAC[®]

High Performance Trays

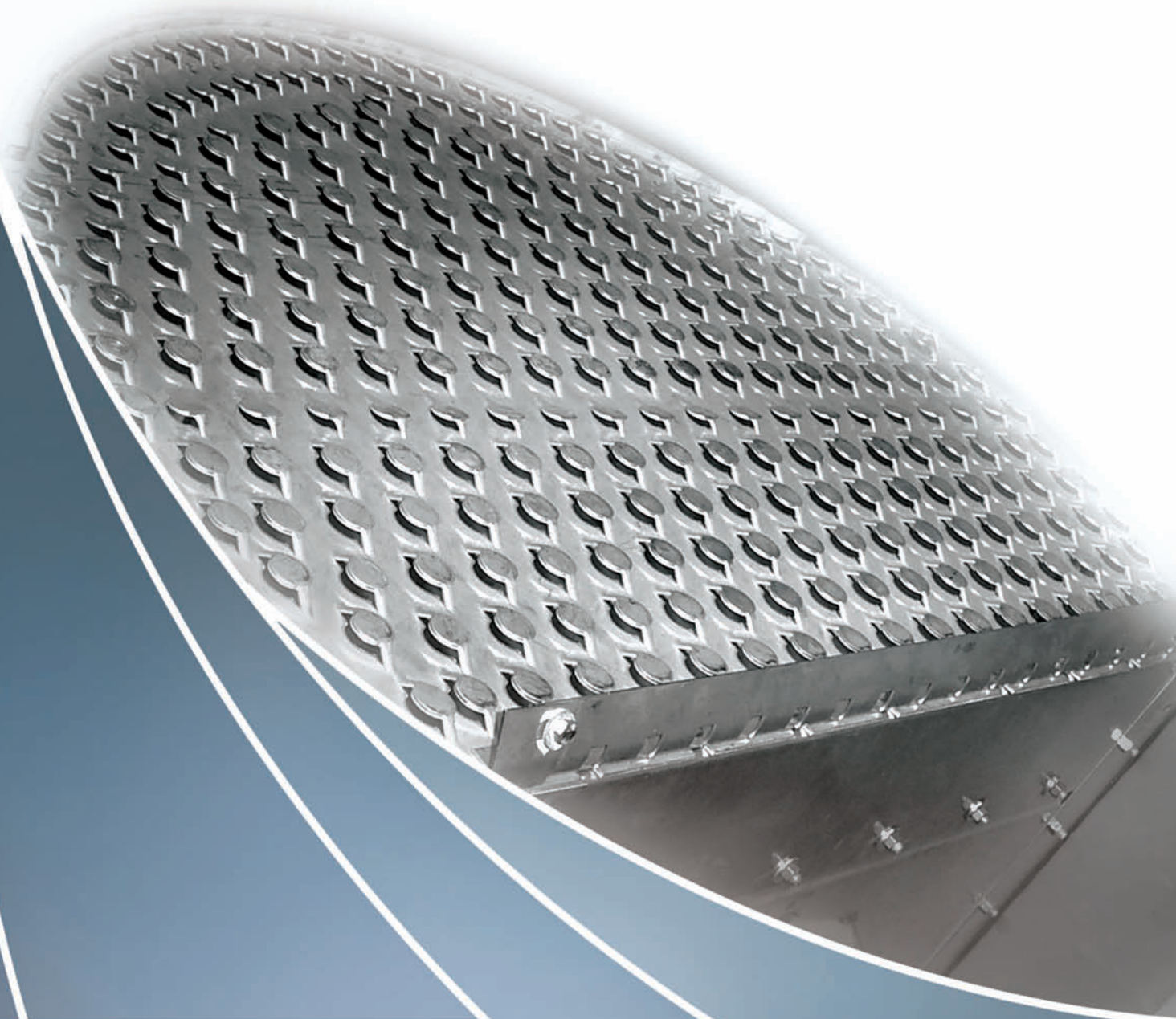

Highest combined capacity & efficiency
crossflow tray tested at FRI

 **KOCH-GLITSCH**

SUPERFRAC[®] High Performance Trays

The SUPERFRAC[®] tray is a high-performance cross-flow tray that has the highest

The patented technologies used in SUPERFRAC[®] Trays (Figure 1) are the culmination of over twenty years of comprehensive tray development work. The unique combination of SUPERFRAC patented technologies and design strategies produces the high capacity and the maximum vapor/liquid contact efficiency achievable on a cross-flow distillation tray as shown in Figure 2. As a result, the SUPERFRAC tray gives the highest economic benefit to operators of distillation columns seeking solutions for both new construction and revamp projects.



Figure 1. Two-Pass SUPERFRAC[®] tray

A well-designed conventional tray generally provides the most economically attractive solution for grass-roots column construction projects. However, as the operator's throughput and product requirements increase, the original trays become the primary constraint. Conventional tray design limitations include:

- Liquid and/or vapor maldistribution that can reduce tray efficiency and lead to premature flooding because of entrainment.
- Less-than-optimal downcomer design that can ultimately result in premature downcomer flooding.

Such performance issues of conventional trays have been recognized for many years. Koch-Glitsch has invested significant research and development resources to understand these issues and to strategically address each one of them. SUPERFRAC trays and the know-how to design and apply them are the products of that investment.

Koch-Glitsch has targeted three major areas for enhancing the performance of conventional trays:

- Advanced downcomer technology
- Active area enhancements
- Inlet area enhancements

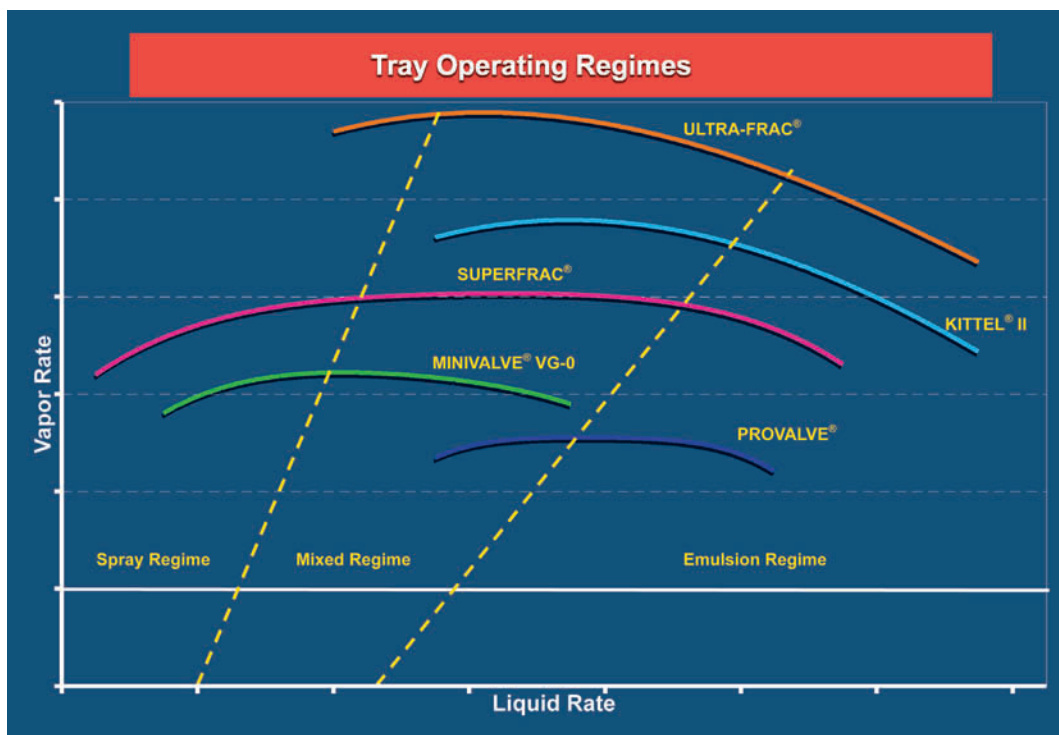

Figure 2. Tray Operating Regimes

Advanced Downcomer Technology

A thorough understanding of downcomer flooding mechanisms in a wide variety of services is critical to successful application of high performance tray technology. Advanced downcomer technology developed by Koch-Glitsch provides the capability to accurately size and shape the downcomer, which provides the following benefits:

- Conventional downcomers for standard tray construction and simple installation
- Truncated downcomers to maximize active area for vapor-liquid contact
- Multi-chordal side downcomer skirts for longer flowpath length and greater efficiency
- Multi-stage downcomers for additional liquid-handling capacity
- Multi-pass downcomers for reduced weir loading and improved column capacity
- PURGE™ downcomers as the ultimate solution for sediments in severe fouling services

Enhancements

Active Area Enhancements

Koch-Glitsch has developed a variety of valve styles and technologies to enhance the vapor-liquid contacting that takes place on a tray deck, including:

- **MINIVALVE®** Decks
 - Fixed valves, see Figure 3
 - Floating valves, see Figure 4
- Large diameter fixed valves
- Bubble promoters
- Proprietary design techniques

The variety of valve styles and technologies are used to enhance the effective bubbling activity on the tray and improve the flow of fluid across the tray. This results in improvement to both hydraulic performance and mass transfer efficiency on the deck.



Figure 3. MINIVALVE Deck - Fixed Valves



Figure 4. MINIVALVE Deck - Floating Valves

Inlet Area Enhancements

Inlet area enhancements, such as bubble promoters, can provide improved capacity, better froth initiation, and improved bubbling activity on the tray, thus also increasing vapor-liquid contact efficiency.

SUPERFRAC trays use inlet area enhancements to eliminate the vapor and liquid maldistribution and stagnant zones that can occur on conventional trays. These enhancements promote uniform flow distribution, which improves the hydraulic performance and contact efficiency of the tray.

Fouling Services

Moderate Fouling Systems

For moderate fouling systems, large diameter fixed valves, such as the VG-10 (Figure 5), or the patented **PROVALVE**[®] unit (Figure 6) can be used on several SUPERFRAC configurations to reduce the tendency to foul.

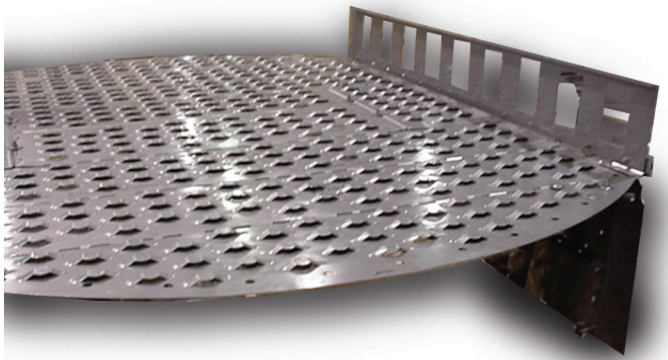

Figure 5. VG-10 Valves

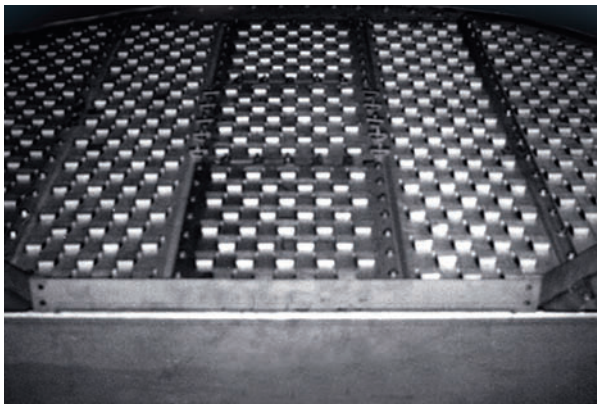

Figure 6. PROVALVE Tray

Extreme Fouling Systems

For extreme fouling services, Koch-Glitsch offers **SUPERFLUX**[®] Trays, which can employ many of the capacity and efficiency features of SUPERFRAC trays. SUPERFLUX trays are designed to increase run time in fouling applications. Koch-Glitsch can address the specific fouling characteristics present in your operation with our proprietary technology offered on SUPERFLUX trays.

The **PURGE**[™] Downcomer (Figure 7) is available for severe fouling applications, such as polymer slurry, acrylonitrile, and butadiene services.

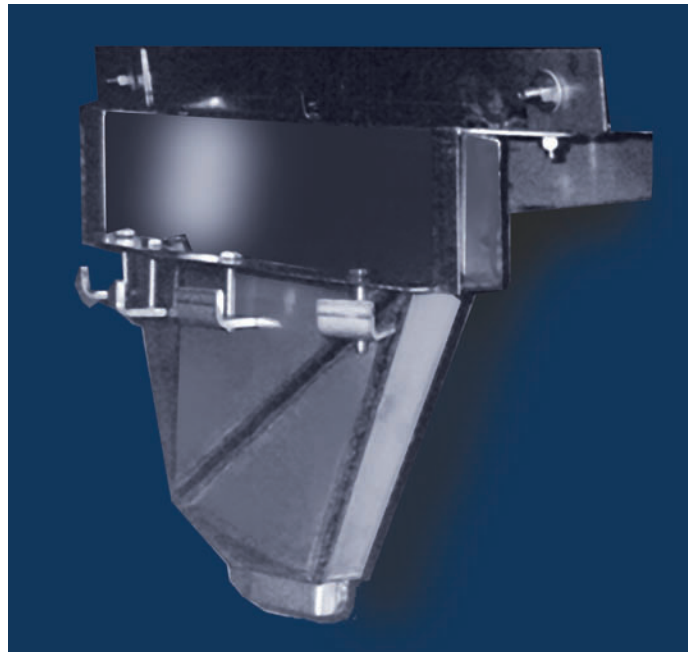

Figure 7. PURGE Downcomer

Emergency Delivery

Emergency Delivery

Koch-Glitsch has a wide variety of tray products to provide optimum performance whatever your application. Many common materials are in stock and trays can be quickly manufactured to get you back on line.

For emergencies, call the Hotline of your nearest Koch-Glitsch office.

- In the US, call the Hotline at 1-888-KOCH-911.
- In Europe, call 0044 1782 744 561, +39-06-928-911 or your local Koch-Glitsch office.

Conventional Downcomer SUPERFRAC® Trays

- ▶ **Diameters from 3 ft [900 mm]**
- ▶ **Fouling resistant with large diameter fixed valves**
- ▶ **Downcomer design provides simple revamps**
- ▶ **No extra active area over conventional designs**

Conventional downcomer SUPERFRAC trays use active area enhancements and may include inlet area enhancements. Refer to page 2 for additional descriptions of enhancements.

The straightforward design of the downcomers allows use of standard tray construction and simplifies installation, which may provide a lower cost solution.

Some improvements in capacity and efficiency are possible over conventional trays by changing the active areas. In some cases, the higher capacity valves and optimized liquid push can achieve revamp goals without downcomer modifications.

Construction Details

- Conventional-style downcomers that are either straight or sloped
- Custom designs for specific application requirements
- Bolted design

Design Options

- Valve options: VG-0, VG-10, PROVALVE, MV-1 and CRV valves
- Optimized liquid push
- Bubble promoters
- **FLEXILOCK®** Construction



Figure 8. Conventional Downcomer SUPERFRAC Trays

PLUS™ Technology for SUPERFRAC® Trays

- ▶ **Diameters from 3 ft [900 mm]**
- ▶ **Applications with low liquid rates**
- ▶ **Available with most downcomer designs**

The patented PLUS Technology acts as a deentrainment device and can decrease the efficiency loss that often occurs in low liquid and high vapor rate applications. In these types of conditions, it is common for high vapor rates to blow the liquid off the trays.

While the PLUS Technology will not prevent a tray from blowing dry, it does help offset the efficiency losses that occur because of high entrainment in low liquid rate services. Gains of 5% in useable (efficient) capacity are typical.

The PLUS Technology is installed below each tray and helps reduce the entrainment of liquid droplets from one tray to the next.

The deentrainment device is a customized design that typically uses a specifically designed **FLEXIPAC®** Structured Packing. Because structured packing is used, this technology typically is not applied in fouling services.

Construction Details

- Fits most SUPERFRAC tray configurations
- Custom designs for specific application requirements
- Installed below tray deck
- Bolted design

Design Options

- Valve options: VG-0, VG-10, PROVALVE, MV-1 and CRV valves
- Optimized liquid push
- Bubble promoters for applicable liquid rates
- Proprietary design techniques
- **FLEXILOCK** construction



Figure 9. PLUS Technology for SUPERFRAC Trays

Truncated Downcomer SUPERFRAC® Trays

- ▶ **Diameters from 3 ft [900 mm]**
- ▶ **Fouling resistant with large diameter fixed valves**
- ▶ **Downcomer maximizes active area in comparison to conventional designs**
- ▶ **Equal or better efficiency in tray-for-tray revamps**

Truncated downcomer SUPERFRAC trays use active area enhancements and advanced downcomer technologies and may include inlet area enhancements.

Several patented truncated downcomer designs are available and are customized to the specific application. The tray design takes the vapor and liquid rates into consideration as well as special requirements, such as fouling service. Figures 10 and 11 show two different downcomer styles.

MINIVALVE decks use either the VG-0 or MV-1 valves with corresponding push valves. The PROVALVE and VG-10 valves are available options that achieve high rates and have larger openings that offer improved reliability for fouling applications.

Capacity gains for these trays can be substantial, particularly in cases where the existing conventional trays had large inlet areas below the downcomers. In these cases, the recovered area under the downcomer can create a drastic increase in capacity. At higher capacities, testing has shown that these trays still maintain high efficiencies. Under most conditions, the efficiency of these trays is higher than conventional trays.

Lower cost options are considered during the design process while recognizing the required capacity and efficiency. More complicated designs are not utilized if simpler ones will suffice.

Construction Details

- Truncated style downcomers that are either straight or sloped
- Custom designs for specific application requirements
- Bolted design

Design Options

- Valve options: VG-0, VG-10, PROVALVE, MV-1 and CRV valves
- Bubble promoters for applicable liquid rates
- Proprietary design techniques
- FLEXILOCK construction

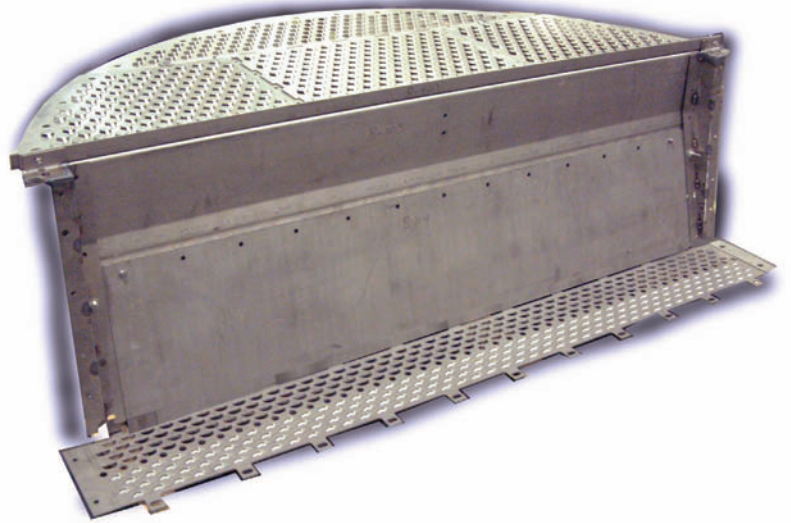

Figure 10. Truncated Downcomer SUPERFRAC Trays

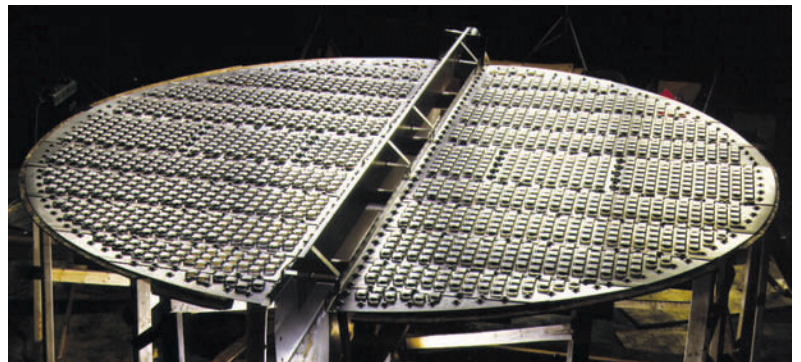

Figure 11. Truncated Downcomer SUPERFRAC Tray with PROVALVE Active Areas

Multi-Chordal Downcomer SUPERFRAC® Trays

- ▶ **Diameters from 3 ft [900 mm]**
- ▶ **Design maximizes active area over conventional designs**
- ▶ **Downcomer design utilizes entire tray space**
- ▶ **Equal or better efficiency in tray-for-tray revamps**

The patented multi-chordal downcomer SUPERFRAC tray (Figure 12) uses active area enhancements and advanced downcomer technologies and may include inlet area enhancements.

One advantage of the multi-chordal downcomer design is that the downcomer uses the full vertical tray space, which minimizes downcomer limitations.

MINIVALVE decks use either the VG-0 or MV-1 valves with corresponding push valves.

Capacity gains for these trays can be substantial particularly in cases where the existing conventional trays had large inlet areas below the downcomers (Figure 13). In these cases, the recovered area under the downcomer can create a drastic increase in capacity. At higher capacities, testing has shown that these trays still maintain high efficiencies. Under most conditions, the efficiency of these trays is higher than conventional trays.

The forward-lateral push provided by the optimized liquid push design promotes uniform liquid and vapor distribution across the entire tray deck. This suppresses jet flooding and permits operation at higher flow rates. The typical liquid recirculation found on most trays results in lower efficiency and capacity. This liquid recirculation is eliminated with the appropriate liquid push design (Figure 14).

The multi-chordal shape of the side downcomer at the bottom provides additional benefits.

- Equalized liquid flow patterns across the tray
- Increased flow path length
- Increased vapor-liquid contact time
- Improved efficiency
- Increased bubbling area and tray capacity

In this design, the bottom downcomer area is located over the tray support ring, thereby utilizing an area that cannot be used as an active area.

The shape of the multi-chordal downcomer allows a conversion from straight to sloped downcomers without the use of downcomer adapter bars. This saves the extra cost of the adapters and the field time needed to install them. It also eliminates the need to weld to the vessel shell.

Construction Details

- Multi-chordal style side downcomers
- Custom designs for specific application requirements
- Bolted design

Design Options

- Valve options: VG-0, VG-10, PROVALVE, MV-1 and CRV valves
- Optimized liquid push
- Bubble promoters for applicable liquid rates
- Proprietary design techniques
- FLEXILOCK construction

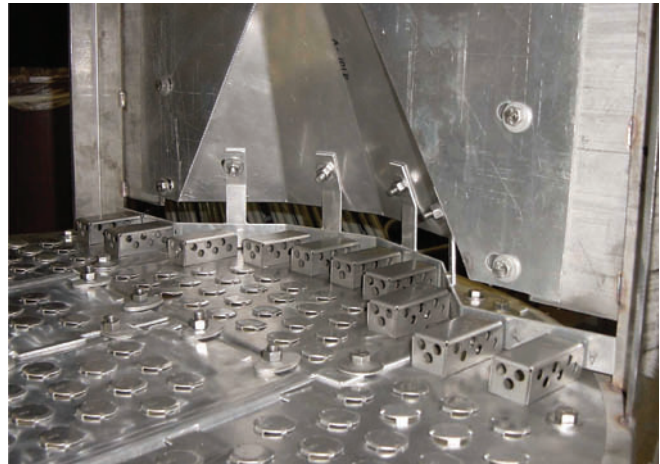

Figure 12. Typical Multi-Chordal Downcomer

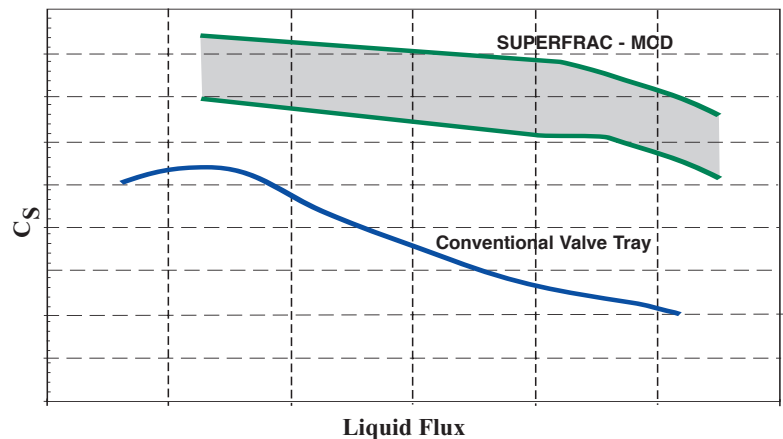

Figure 13. SUPERFRAC and Conventional Tray Capacity Curves

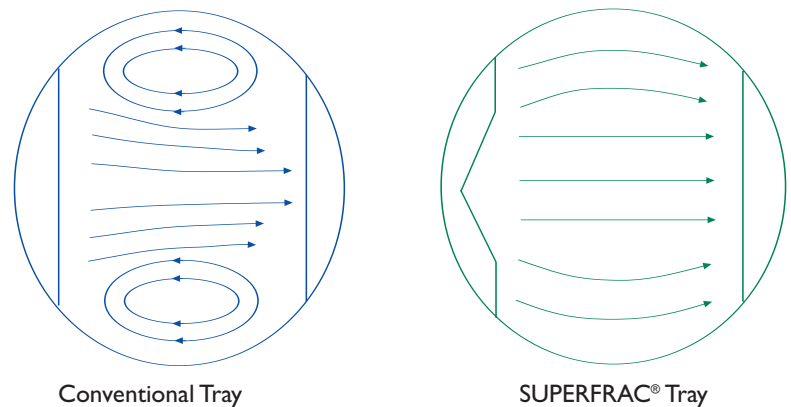

Figure 14 Liquid Flow Distribution Comparison

Multi-Stage Downcomer SUPERFRAC® Trays

- ▶ **Diameters from 3 ft [900 mm]**
- ▶ **Specifically designed for high liquid rates**
- ▶ **Downcomer design maximizes active area and utilizes entire tray space**

The patented multi-stage downcomer SUPERFRAC tray (Figure 15) uses active and inlet area enhancements and the most advanced downcomer technologies.

The multi-stage downcomer is used only for high liquid loads with weir loadings in excess of 120 gpm/ft (90m³/hr/m) and is custom designed for each application's requirements. One advantage of the multi-stage downcomer design is that the downcomer uses the full vertical tray space, which minimizes downcomer limitations.

The additional liquid-handling capacity of the multi-stage downcomer can often eliminate the need for downcomer adapters. This reduces installation time and lowers equipment and field labor costs. It can also reduce downcomer backup by lowering the amount of liquid that must pass under the downcomer edge.

Capacity gains for these trays are substantial. At high capacities, testing has shown that these trays still maintain high efficiencies. Under most conditions, the efficiency of these trays is higher

Construction Details

- Multi-chordal style side downcomer
- Custom designs for specific application requirements
- Bolted design
- Bubble promoters

Design Options

- Valve options: VG-0, VG-10, PROVALVE, MV-1 and CRV valves
- Optimized liquid push
- Proprietary design techniques
- FLEXILOCK construction

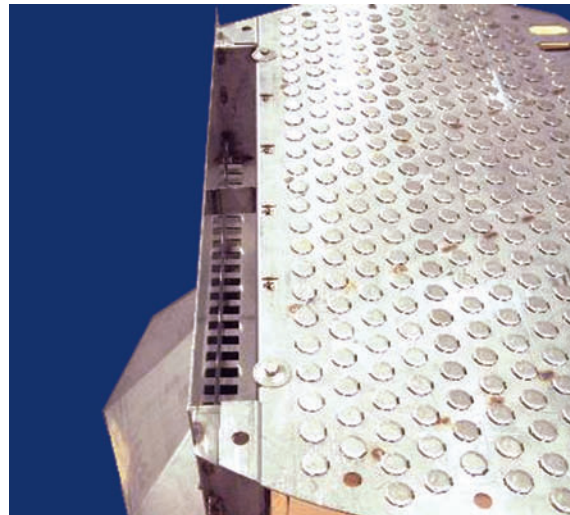

Figure 15. Multi-Stage Downcomer SUPERFRAC Trays

Multi-Pass Downcomer SUPERFRAC® Trays

- ▶ **Diameters from 13 ft [3962 mm]**
- ▶ **High liquid rates**
- ▶ **Multiple downcomer designs**

In larger diameter columns, typical multi-pass designs are limited to four passes. However, for applications that require more than four passes, the proprietary multi-pass downcomer design can be used to reduce weir loading and improve the capacity of the column.

Koch-Glitsch has successfully designed large diameter columns that use these multi-pass design techniques in 6-pass or 8-pass configurations. Modest capacity increases with these trays are possible in comparison to the best designed 4-pass SUPERFRAC trays.

The downcomer configuration for a multi-pass design typically is the multi-chordal design; however, virtually any other configuration can be used.

Construction Details

- Truncated, multi-chordal or multi-stage downcomer design
- Custom designs for specific application requirements
- Bolted design
- Bubble promoters

Design Options

- Valve options: VG-0, VG-10, PROVALVE, MV-1 and CRV valves
- Optimized liquid push
- Customized downcomer design
- Proprietary design techniques
- FLEXILOCK construction



Figure 16. Multi-Pass Downcomer SUPERFRAC Trays

SUPERFLUX® Trays

- ▶ **Diameters from 3 ft [900 mm]**
- ▶ **Fouling resistant with large fixed valves**
- ▶ **Conventional downcomer design allows simple revamps**
- ▶ **PURGE™ Downcomer design is the ultimate solution for sediments**
- ▶ **Directional valves promote self-cleaning of active area**

To ensure the appropriate technologies are applied for each **SUPERFLUX®** Tray design, the client is contacted for specific characteristics of fouling that must be addressed. Features suitable for the specific application are then combined into a final design to produce a tray capable of longer run times between cleaning shutdowns.

Conventional Downcomers

SUPERFLUX trays with conventional downcomers use active area enhancements and may have inlet area enhancements. Large diameter fixed valves that are fouling resistant are a standard feature (Figure 17).

The straightforward design of the downcomers allows the use of standard tray construction and simplifies installation.

SUPERFLUX trays provide increased fouling resistance, which can lead to increased run times. Several valve options are available that promote self-cleaning of the active areas. These valves have directional components that utilize vapor energy to provide forward-lateral push on the froth. This action is critically important to maintain proper tray activity and reduce residence time of solids on the tray deck.

Particular attention is paid to the peripheral areas of the deck where stagnation may lead to solids deposition. Directional valves are placed in this area to both increase activity as well as promote a uniform flow profile. These components combine to reduce the residence time distribution and enhance the fouling resistance of the trays.

Such a tray design is suitable for processes which are particularly prone to active area fouling, such as sour water strippers and beer strippers. In processes where downcomer fouling is known to cause frequent shutdowns, we recommend the PURGE™ Downcomer configuration.

PURGE™ Downcomers

If conventional downcomers do not provide the optimum design for resisting fouling in your application, Koch-Glitsch offers the PURGE downcomer (Figure 18). For very severe applications, the PURGE downcomer has proven suitable to resist fouling for such services as polymer slurry, acrylonitrile, and butadiene services.

The PURGE downcomer SUPERFLUX trays use active area enhancements and may have inlet area enhancements. Very specific advanced downcomer

Construction Details

- Conventional style downcomers that are either straight or sloped.
- PURGE downcomers for very severe services
- Custom-engineered design for specific application
- FLEXILOCK construction

Design Options

- Valve options: VG-0, VG-10, PROVALVE valves
- Proprietary design techniques
- Bolted design
- Electropolishing

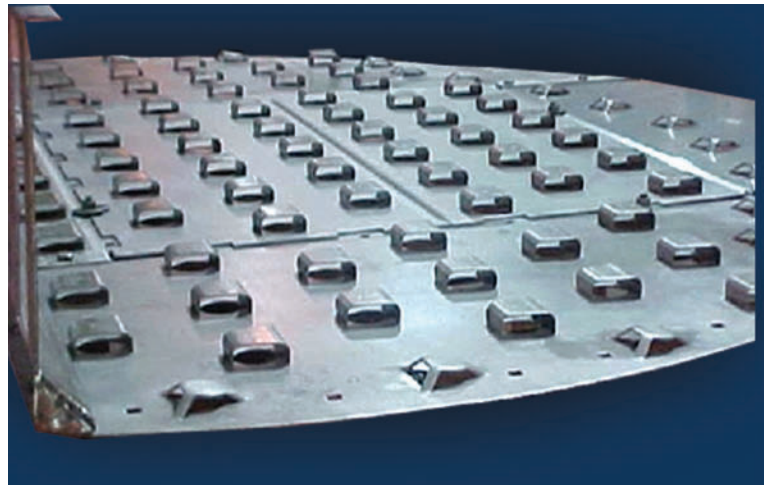

Figure 17. SUPERFLUX Tray for Bioethanol Beer Stripper

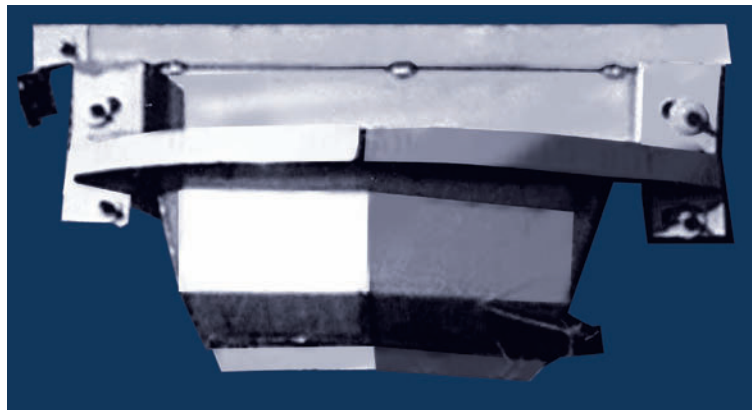

Figure 18. SUPERFLUX Tray with PURGE Downcomer Option

Mechanical Features

OMNI-FIT® Technology

OMNI-FIT technology is a set of mechanical engineering designs used to reduce the cost and downtime of revamps. These technologies include expansion rings, pedestal supports, downcomer adapters, and innovative tray designs that can minimize or eliminate welding on an existing tower. Efficiency and capacity enhancements can be achieved by using OMNI-FIT technology for your next turnaround project.

OMNI-FIT technology can be used to:

- ▶ Increase theoretical stages
- ▶ Change tray spacings
- ▶ Change the number of passes
- ▶ Modify downcomer sizes or configurations
- ▶ Install multi-pass SUPERFRAC trays
- ▶ Change tray orientation
- ▶ Eliminate welding
- ▶ Shorten turnarounds
- ▶ Replace packing
- ▶ And more...



Before

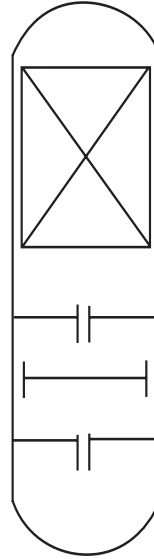

After

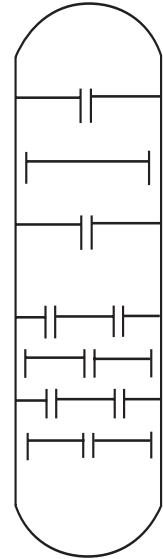

Figure 19. Revamp using OMNI-FIT Technology

FLEXILOCK® Tray Construction

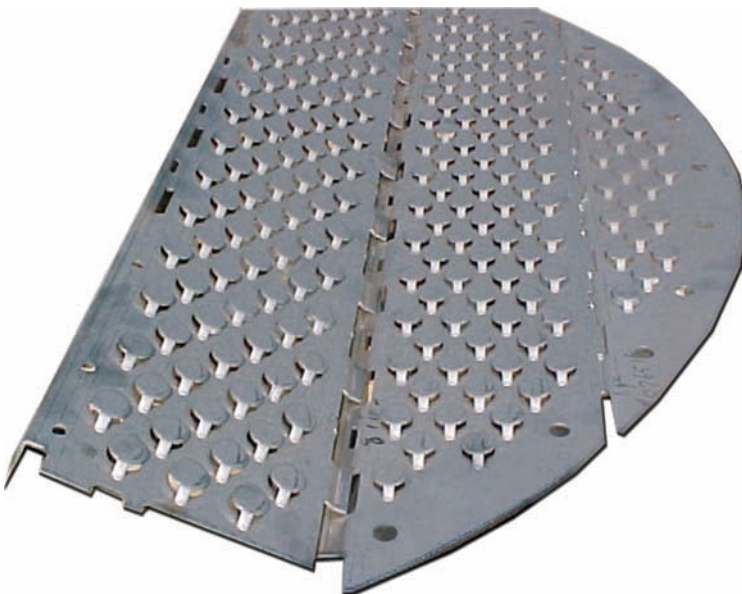

Figure 20. FLEXILOCK Tray Construction

The patented FLEXILOCK tray joint allows rapid installation of tray panels in vessel shops or in the field. FLEXILOCK tray construction eliminates the requirement for hardware between adjacent tray panels and provides for error-free deck installations.

FLEXILOCK tray construction can be used to:

- ▶ Reduce hardware requirements
- ▶ Improve valve coverage
- ▶ Provide error-free deck installation
- ▶ Dramatically reduce installation time
- ▶ Strengthen joint and uplift tolerance
- ▶ Promote in-shop installations
- ▶ Cancel vibration-induced panel shifting

HORIZON[®] Technology

HORIZON technology is a set of mechanical construction techniques developed specifically for in-shop installation of trays with the vessel in the horizontal position. Using the patented FLEXILOCK tray construction as its primary building block, this special mechanical design prevents the problems that can occur when conventionally designed trays are installed with the vessel in the horizontal position. These problems include inefficient installation sequencing, part deforming/breaking, panel shifting, joint dislodging, extra field inspecting and field readjusting of tray parts.

If you plan to shop-install trays, then you need the assurance provided by HORIZON technology.



Figure 21. HORIZON Construction Enhancements

SATURN[®] Technology

The patented SATURN technology can reduce the total installed cost of new distillation columns with its combination of innovative tray designs and simple tower attachments.

When crossflow trays are used, conventional designs use horizontal ring segments to support trays decks and vertical bolting bars to support tray downcomers. With the SATURN technology, all of the cross flow tray parts are supported from the horizontal ring.

SATURN technology brings together:

- ▶ The high efficiency, high capacity, low cost, and reliability of crossflow trays
- ▶ The simple rings of dualflow trays

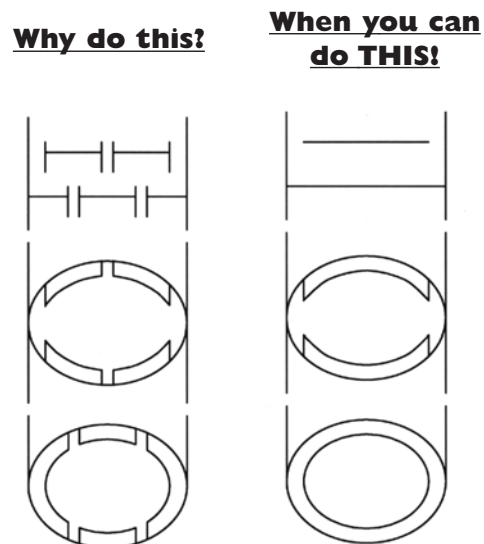

Figure 22. Application of SATURN Technology

SPEED-WAY[®] Manways

At last, a design that allows you to easily add quick-opening manways to your existing trays. Just remove the existing manway or active panels and replace them with SPEED-WAY panels (Figure 23).

These quick-opening manways are especially beneficial when:

- ▶ Turnaround manpower is limited
- ▶ Short downtime is critical
- ▶ Routine inspections are required

If you have a need to tunnel through your column on a routine basis, SPEED-WAY manways are a must.

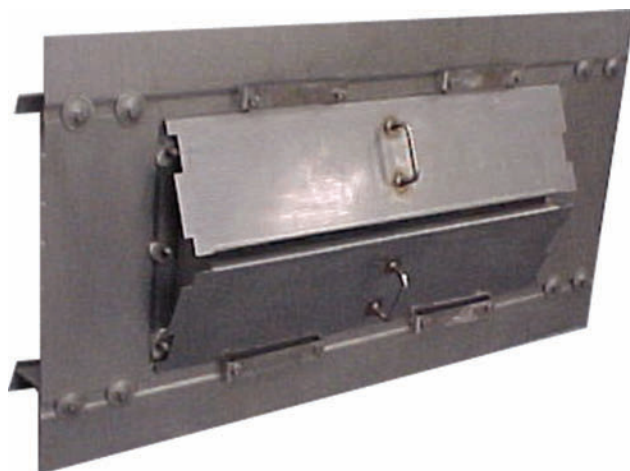

Figure 23. SPEED-WAY Manways

Construction Details

Metal

Trays are available in any formable, weldable sheet metal material. The most common materials for trays are:

- Carbon steel
- Stainless steel, Ferritic, Austenitic, Duplex, Martensitic
- Nickel alloys
- Copper alloys
- Titanium, Zirconium

Trays are not normally stress relieved or annealed and typically do not conform to pressure vessel standards.

Trays fabricated from sheet metal materials are typically supplied in "as-sheared" condition.

Bolting

Standard bolting conforms to AISI specifications. Bolting conforming to ASME specifications is available by special request.

Certification

Material certification is available for all fabricated internals. Positive Material Identification (PMI) testing is available by special request.

Gasketing

For multi-piece trays requiring gasketed joints, many choices of gasket material are available. Where gasketing is required, braided fiberglass tape is supplied as the standard for linear joints. Depending on the service, FLEXITALLIC® SF2400, expanded PTFE or spiral wound stainless steel with flexible graphite filler gaskets are supplied as the standard for flanged connections. Other gasket materials are available by special request.

Manway Access

All trays are designed in sections to pass through vessel manways. Tower internals are designed to pass through a vessel manway of 18 in [450 mm] minimum inside diameter, unless otherwise specified. Larger manways often provide the ability to optimize the design of components for faster, easier installation. Please provide manway locations and inside diameters at the time of inquiry.

Scope of Supply

For the trays in this brochure, Koch-Glitsch supplies all removable parts.

The trays do not include vessel attachments for connection or support, unless specifically stated in the item description. Vessel attachments may be quoted/supplied separately. Examples of attachments that may be required are:

- Support rings
- Sump frames
- Internal flanges at feed inlet nozzles
- Wall clips for support
- Downcomer clamping bars
- Beam seats

Minimum Support Ring

All dimensions are expressed as inches [millimeters]		
Tower ID	Trays Resting on or Clamped to Support Ring	Trays Through-Bolted or Using Leveling Screws
Up to 18 [Up to 457]	0.75 [20]	1.5 [40]
18.1 – 24.24 [458 – 615]	1.0 [25]	1.5 [40]
24.25 – 48.24 [616 – 1225]	1.5 [40]	2.0 [50]
48.25 – 72.24 [1226 – 1835]	2.0 [50]	2.0 [50]
72.25 – 96.5 [1836 – 2450]	2.5 [65]	2.5 [65]
96.6 – 144.5 [2451 – 3670]	3.0 [75]	3.0 [75]
144.6 – 168.7 [3671 – 4285]	3.5 [90]	3.5 [90]
168.8 – 216.3 [4286 – 5495]	4.0 [100]	4.0 [100]
216.4 – 240.5 [5496 – 6110]	4.5 [115]	4.5 [115]

If the support ring size is other than these listed above, special consideration must be given to the plate diameter and vessel tolerances.

Figure 24. Minimum Support Ring Widths

Feed Devices

Obtaining desired tower performance requires the proper handling of liquid and vapor entering the column. The types of feeds or inlets into a column can generally be classified into three major categories:

- Liquid only (contains less than 1% of vapor by volume)
- Mixed liquid and vapor, flashing or suppressed flash
- Vapor

The selection criteria for each category of feed device is unique

Liquid-Only Feeds

Among the factors Koch-Glitsch considers in designing a liquid feed device are:

- Type of tray
- Expected tray performance
- Flow rate
- Operating range
- Degree of sub-cooled liquid
- Requirements for mixing

The feed arrangement for these conditions depends on the tray type. Please consult with a Koch-Glitsch technical representative for recommendations.

Liquid-Vapor and Flashing Feeds

For mixed liquid-vapor or flashing feed devices above a tray, the selection depends on:

- Tray type
- Liquid and vapor flow rates
- Turndown
- Column height needed for disengagement and vapor distribution
- Requirements for mixing

In all cases, separating the vapor and the liquid phases is a primary concern. In some cases, the requirements for additional pre-distribution may alter certain tray designs.

Vapor-Only Feeds

Two factors must be considered when choosing the proper device for a vapor-only feed.

- The kinetic energy of the inlet vapor in relation to the pressure drop across the trays, the feed nozzle arrangement and the tower separation requirements.
- If there is a large difference in the composition and/or temperature between the inlet vapor stream and bulk vapor flow, mixing the two vapors optimizes the performance of the trays.

Specific equipment for vapor distribution may not be required if sufficient column height is available for equalization or if the pressure drop across the trays is sufficient to provide proper vapor distribution.

CFD Modeling

Good vapor distribution is essential to achieve superior separation efficiency. Poor vapor distribution is often a major source of problems.

Koch-Glitsch combines modern Computational Fluid Dynamics (CFD) modeling technology with its engineering expertise to analyze vapor and liquid distribution when evaluating the performance of existing equipment and developing new, improved designs. This involves computer modeling of the 3- dimensional configuration of the column internals to provide detailed predictions of fluid flow (velocity profiles, and so forth). See Figure 25.

Koch-Glitsch offers CFD services for the following tasks:

- Development and optimization of new mass transfer equipment
- Troubleshooting or analysis of existing equipment
- Confirmation of equipment designs prior to fabrication and installation

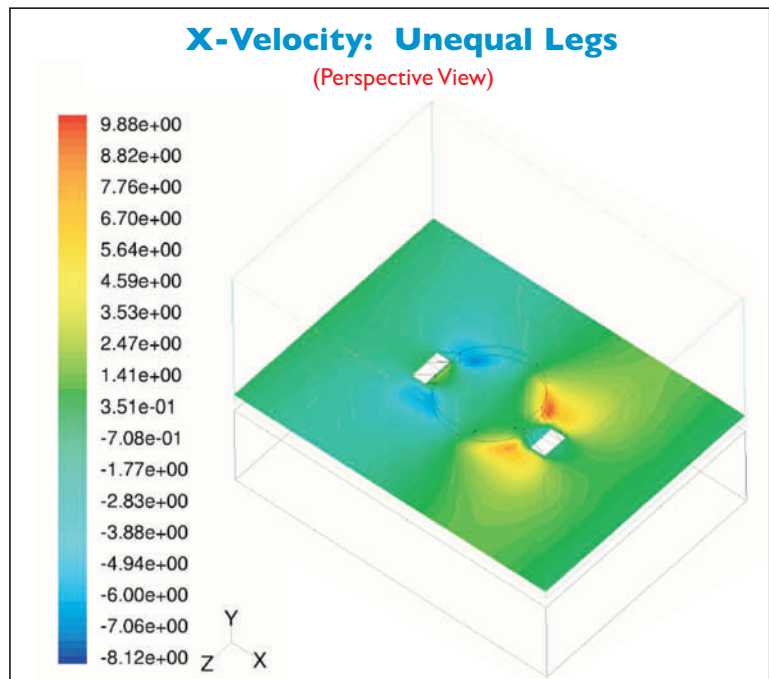

Figure 25. CFD Study for Single VG-0 Valve

Applications

SUPERFRAC trays can be used in new construction and revamp opportunities for virtually any service in which conventional sieve and valve trays are used. They are especially beneficial in applications requiring a large number of mass transfer stages, or where mass transfer efficiency is critical to the economics of the operation. Examples include superfractionators (ethylene, propylene), light hydrocarbon fractionators, splitters in chemical and petrochemical applications and aromatic services.

C₃ Splitter Revamp with Multi-Chordal, Multi-Pass SUPERFRAC® Trays

A significant revamp of a C₃ splitter unit was completed in 2000 to obtain additional capacity over first generation high capacity trays. Because of the number of stages involved in this propylene / propane separation, the splitter is actually two columns. The feed is to the middle of the lower column, which has both a stripping and a rectifying section. The upper column contains additional rectifying trays. Figure 26 is a simplified process flow diagram of the unit.

The tray design changes included SUPERFRAC style downcomers to maximize active area, push valves, fixed MINIVALVE units, higher open area, reduced weir height, number of passes increased to six, and tray space increased below the feed.

OMNI-FIT revamp techniques were used to change the number of passes and tray spacing without welding to the column shells. In addition, the feed inlet nozzle was relocated to a higher position on the column.

Even with the 6-pass design and reduced flow path length, the overall tray efficiency was still measured in the 90% to 95% range. The end result was good efficiency and at least a 15% capacity improvement over the previous high capacity trays.

The table below summarizes some of the results.

	Before	After
Diameter, ft	16	16
Tray Configuration	4-Pass	6-Pass
Tray Type	1st Generation High Capacity Trays	Multi-Chordal SUPERFRAC Trays
Deck Type	Movable Valves	VG-0
Above Feed		
Number of Trays	196	178
Tray Spacing, inches	22	22
Below Feed		
Number of Trays	44	49
Tray Spacing, inches	22	27.5
Propylene Rate, MM lb/yr	820	958
Max wt% Propane Overhead	0.4%	0.4%
Max lb% Propylene Bottoms	5.0%	5.0%

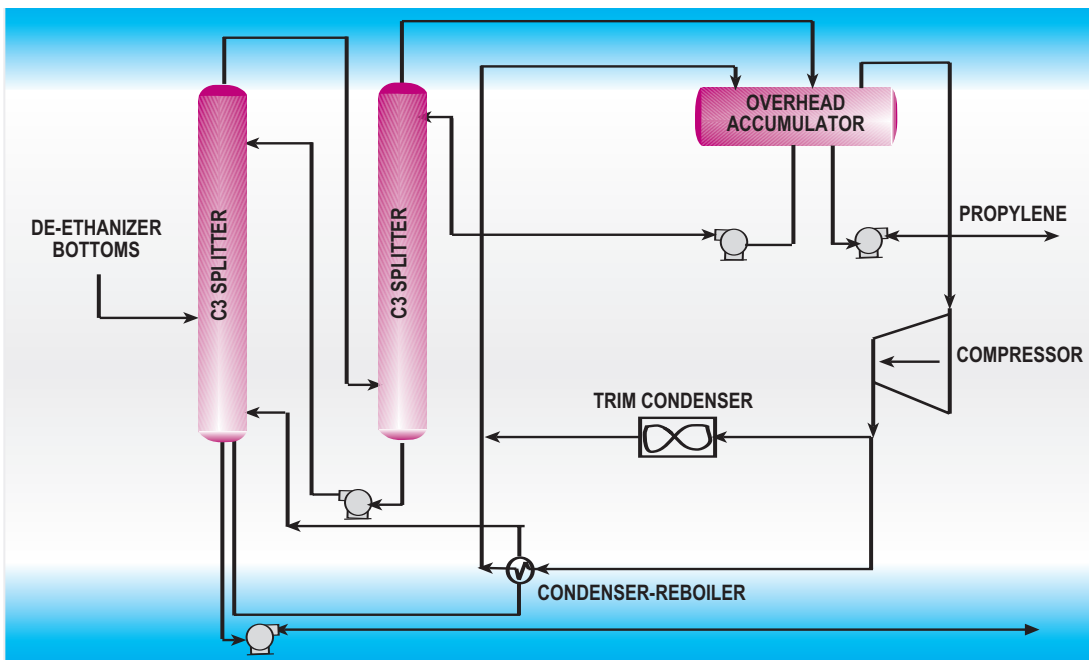

Figure 26. C₃ Splitter Simplified Process Flow Diagram

Depropanizer Revamp with Two Types of SUPERFRAC® Trays

In 1990, the sieve trays in the rectifying section were upgraded and the stripping section trays were replaced with **INTALOX®** Structured Packing to increase the capacity from 4,000 barrels per day to 6,000 barrels per day. In 2000, the operator wanted to increase the capacity again. At that point, the sieve trays in the rectifying section were the limitation. These trays were replaced with conventional and truncated downcomer **SUPERFRAC** trays.

The column now handles a maximum feed rate of 7,100 barrels per day. Upstream equipment, and not the column internals, now limits the capacity of the column. The next limitation in the column will most likely be the structured packing. A post-revamp performance test indicates that the **SUPERFRAC** trays in the rectifying section are operating with tray efficiencies in excess of 100%.

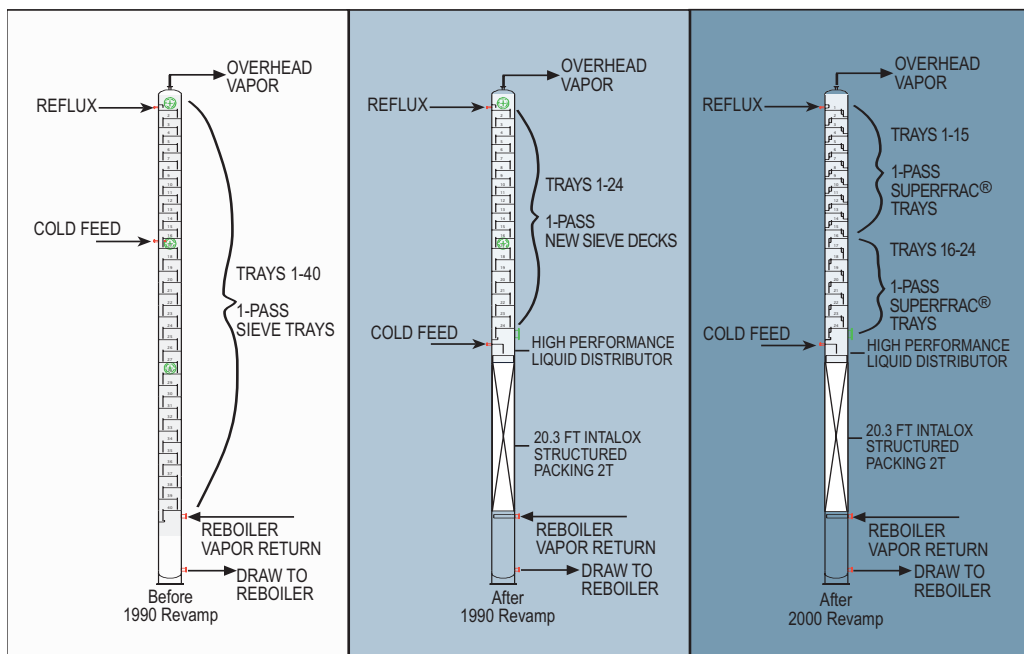

Figure 27. Column Layouts Before and After Revamps

EDC Heavy Ends Column Revamp

A Vinyl Chloride Monomer producer wanted to revamp its EDC Heavy Ends column to achieve a significant capacity increase and eliminate frequent shutdowns because of tray fouling. Simulations of the operating data, evaluation of the tray hydraulics, and a gamma scan of the column revealed that the existing sieve trays were at their operating limit.

The column upgrade included:

- Replacing all one-pass sieve trays above the feed with one-pass **SUPERFLUX®** Trays on the same 15 in. tray space.
- Increasing tray spacing below the feed from 15 in. to 18 in. without welding in new tower attachments.
- Replacing the tray immediately below the feed with a transition tray, which was used to mix the liquid from the tray above with the liquid from the feed and to distribute the mixed liquid to the two-pass trays below.
- Using expansion tray rings and special downcomer adapters to support the new **SUPERFLUX** trays and eliminate field welding to the vessel wall.

During the test run, the target design rate of 110% was met at the midpoint of the first day with a target purity of 99.6% EDC in the overhead product stream. The product specification for the 1,1,2 Trichloroethane impurity in the overhead was also met. Even though three trays were eliminated in the column because of increased tray space, the required product purities were achieved at the same reflux rate.

The column has operated at 124% of original capacity over a two-year period and has not lost operation time because of tray fouling. A comparison of the column's performance before and after the revamp is shown in the table below.

	Before Revamp	After Revamp
Feed Rate, gpm	327	406
OVHD Product Rate, gpm	310	385
OVHD EDC Purity, wt%	99.60	99.61
OVHD Temperature, °F	221	236
Bottom Temperature, °F	250	252 – 257
Column Pressure Drop, psi	9.0	8 – 9.5
Capacity	100%	124%
Reflux Ratio (L/D)	0.48%	0.45 – 0.52%

Koch-Glitsch Corporate Offices

Worldwide Headquarters European Offices

Koch-Glitsch, LP
P.O. Box 8127
Wichita, KS 67208-0127
4111 E. 37th Street North
Wichita, Kansas 67220
Tel: (316) 828-5110
Fax: (316) 828-5263

Koch-Glitsch Italia S.r.l.
Viale Giulio Cesare, 29
24124 Bergamo
Bergamo, Italy
Tel: +39-035-227-3411
Fax: +39-035-227-3400

North American Offices

Koch-Glitsch, LP
12221 E. Sam Houston Parkway N.
Houston, Texas 77044
Tel: (713) 427-7600
Fax: (713) 427-7613

Koch-Glitsch (UK) Ltd
King Street, Fenton
Stoke-on-Trent ST4 2LT
United Kingdom
Tel: +44-1782-744-561
Fax: +44-1782-744-330

Koch-Glitsch, LP
4900 Singleton Blvd.
Dallas, Texas 75212
Tel: (214) 583-3000
Fax: (214) 583-3377

Koch-Glitsch Canada, LP
18 Dallas St.
Uxbridge, Ontario
L9P 1C6, **Canada**
Tel: (905) 852-3381
Fax: (905) 852-7821

Asia Offices

Koch-Asia Pacific, Inc.
7th Floor, Kss Gotanda Bldg. 21-8
Nishi Gotanda 1-chome
Shinagawa ku, Tokyo
141-8538, Japan
Tel: +81-3-5435-8560
Fax: +81-3-3491-3523

Koch-Glitsch Korea, Ltd
Dongsung Bldg. 8th Floor
17-8 Yoido-dong
Yongdungpo-ku
Seoul 150-010, Korea
Tel: +82-2-337-2650
Fax: +82-2-780-1954

Koch-Glitsch India, Ltd
42, Kalpataru Court
Dr. Choitram Gidwani Marg
Chembur, Mumbai 400 074,
India
Tel: +91-022-2520-2050
Fax: +91-022-2520-2040

For a complete listing of
Koch-Glitsch offices,
visit us on the internet:
www.koch-glitsch.com

For emergencies:
1-888-KOCH-911

TRADEMARKS

KOCH-GLITSCH®, SUPERFRAC®, MINIVALVE®, PROVALVE®, SUPERFLUX®, FLEXILOCK®, FLEXIPAC®, OMNI-FIT®, HORIZON®, SATURN®, INTALOX®, and SPEED-WAY® are registered trademarks of Koch-Glitsch, LP.

KOCH-GLITSCH® is registered in the US, CTM, UK, CN, ID, JP, KR, MY, SG, TW, TH, and VE. SUPERFRAC® is registered in the US, CZ, SK, ES, CN, IN, ID, JP, KR, MY, SG, TW, TH, AR, MX, and VE. MINIVALVE® is registered in the US, CN, ID, KR, and TW. PROVALVE® is registered in the US, CA, CTM, CZ, HU, CH, AU, JP, PK, RU, SA, SG, TW, MX, VE, and ZA. SUPERFLUX® is registered in the US, CN, ID, KR, SG, and TW. FLEXILOCK® is registered in the US. FLEXIPAC® is registered in the US, CH, BN, ID, JP, KR, SG, TW, TH, AR, MX, and VE. OMNI-FIT®, HORIZON®, SATURN®, and SPEED-WAY® are registered in the US and CTM. INTALOX® is registered in the US, CA, BENELUX, FI, FR, DE, IT, NO, SE, UK, AU, CN, IN, JP, KR, NZ, BR, MX, and ZA.

FLEXITALLIC® is a registered trademark of FLEXITALLIC COMPANY.

NOTES

The illustrations of SUPERFRAC trays show one possible configuration for each tray and are intended to demonstrate the overall function of each type. Actual tray designs are optimized in response to specific process conditions and may have construction details that differ from those indicated in this brochure.

The information contained in this bulletin is believed to be accurate and reliable but is not to be construed as implying any warranty or guarantee of performance.

PATENTS

Fixed MINIVALVE® VG-0	U.S. Patent No. 5,147,584
Movable MINIVALVE® MV-I	U.S. Patent No. 5,120,474
Multi-Stage Downcomer	U.S. Patents No. 5,213,719, 6,053,484
Truncated Downcomer	U.S. Patents No. 5,453,222, 5,480,595, 5,632,935, 5,618,473
PLUS™ Technology	U.S. Patent No. 5,762,668
Multi-chordal Downcomer	U.S. Patents No. 5,895,608, 6,003,847
Bubble Promoters	U.S. Patent No. 5,895,608
PROVALVE® Decks	U.S. Patent No. 5,762,834
FLEXILOCK® Tray Construction	U.S. Patent No. 6,592,106
SATURN® Technology	Patent Pending
SPEED-WAY® Manways	Patent Pending

KOCH-GLITSCH

The Fundamental Driving Force

IN MASS TRANSFER TECHNOLOGY